



*GE Lighting*

# MINIATURE/SEALED BEAM LAMP CATALOG







# MINIATURE & SEALED BEAM

## Table of Contents

Introduction . . . . . 2  
 General Information . . . . . 2, 3  
 Important Notice . . . . . 3  
 Numerical Index . . . . . 4-19  
   Miniature . . . . . 4-14  
   Neon Glow . . . . . 15  
   Sealed Beam . . . . . 15-19  
**All-Glass Wedge Base Lamps**  
 Information . . . . . 20  
**Halogen Cycle Lamps**  
 Information . . . . . 20-21  
 Design Features . . . . . 21-22  
**Miniature Lamps**  
 Design Features . . . . . 22-24  
 Filaments & Bases . . . . . 24  
 Specifications . . . . . 25-46  
**Neon Glow Lamps**  
 Specifications . . . . . 47  
**Sealed Beam Lamps**  
 Filaments & Bases . . . . . 48  
 Specifications . . . . . 49-55  
 Sales Offices . . . . . Back Cover

## Introduction

GE sealed beam and miniature lamps are designed for those applications requiring specific size, long life, and low cost. These lamps are available with a wide variety of filament constructions, bases, and wire terminal leads. Most are designed for operation on low-voltage power sources such as battery-generator systems, dry cell or storage batteries, or transformers. Manufacturers and designers of equipment requiring lamps should select lamps of established design whenever possible for maximum economy as well as ease of replacement through regular trade channels.

Lamps in this catalog are grouped alphabetically, "B" to "T", by bulb size. The letter refers to the bulb shape, and the number is the approximate diameter in eighths of an inch. For example, T-2 means approximately 2/8 inch or 1/4" diameter. The approximate diameter is also given in inches followed by the metric equivalent in parentheses. At the present time, the English units are the overriding dimensions. Lamps are listed in ascending order of design volts within the particular group.

## General Information

GE Miniature Lamps are listed numerically in the Index on pages 4-15. All lamp parameters are subject to normal manufacturing tolerances.

The abbreviations used in this catalog include:

- |                       |                         |
|-----------------------|-------------------------|
| A — Amperes           | Pf. — Prefocus          |
| Bay. — Bayonet        | Sc. — Screw             |
| C.P. — Candlepower    | S.C. — Single Contact   |
| Cand. — Candelabra    | Spec. — Special Term. — |
| D.C. — Double Contact | Terminals               |
| Flg. — Flanged        | V — Volts               |
| Index — Indexing      | W — Watts               |
| Min. — Miniature      |                         |

Information given in the specifications columns on pages 25-47 covers the electrical and physical characteristics of GE miniature lamps. This information includes:

### Line Number

The line number is used to find specific lamps and has no ordering or technical significance.

### Lamp Number

Lamps are marked, in nearly all cases, with a General Electric Trade Number recorded with the American National Standards Institute.



# LAMP CATALOG

## Primary Application

The primary application column lists the original major service of each lamp. However, lamps may be, and are, used in many other applications where their designs may prove advantageous. This column also lists any unique features of the lamp.

## Design Volts

This column lists the voltage at which the lamp is designed for rated amperes, candlepower, and laboratory-life characteristics.

## Design Watts or Amps

The power consumption (watts) or current rating (amps) at the design voltage is listed in this column. In the case of dual-filament lamps, the values for each filament are given.

## Approximate Mean Spherical Candlepower

The value shown in this column is the initial mean spherical candlepower at the design voltage. Mean spherical candlepower is the generally accepted method of rating the total light output of miniature lamps. To convert this rating to lumens, multiply it by 12.57 (4 pi).

## Light Center Length

Light center length indicates the location of the filament with reference to the lamp base.

The light center length is measured from the geometric center of the light source to a particular point of the base. This point is shown on the lamp drawing.

## S.C. and D.C. Prefocused Base Lamps

The letter "A" following the base type designates that the distance from the bottom of the collar to the bottom of the base contact is 13/32". For "B" bases this distance is 9/16".

The few lamps identified by the letter "S" in the "Base" column are special in that the collar location and/or the orientation of the contacts differs from the above.

## Maximum Overall Length

The dimension which includes the bulb and base is designated as the overall length of the lamp. In the case of wire terminal lamps, this dimension applies only to the glass portion. The figures listed here are maximum.

## Rated Average Life

Rated average life is that obtained in closely controlled laboratory testing of lamps at their design voltage. It is not necessarily the same as service life; shocks, vibration, voltage fluctuations, temperature, and other environmental influences may result in a shorter service life.

## Figure Number

The figure number corresponds to the lamp drawing. The drawing shows the correct bulb and base, but not the filament, for the lamp listed. For filament drawings, refer to Table of Contents.

## Important Notice

This catalog contains accumulated data to January 1991. Additional information is constantly being uncovered through research and testing, which may modify the data given herein. This is particularly true of newer lamps. Accordingly, SPECIFICATIONS ARE SUBJECT TO CHANGE WITHOUT NOTICE. For the latest lamp design data and information, contact your GE Lamp Representative.

The data and suggested applications contained in this catalog, as well as any additional information our representative may be able to furnish, are for general information only and are not intended and should not be taken as representations or warranties as to the suitability of a lamp for any particular application or use in any particular equipment, nor are our representatives authorized to make any such representations or give any such warranties. Applications and conditions of use are many and varied, and beyond our control. We cannot possibly have the same degree of knowledge that the purchaser has with respect to the design of his equipment and the conditions of its use. Therefore, it is up to the purchaser to make his own determination as to the suitability of a lamp for his intended application or use and to assume the responsibility for that determination.

General Electric desires to supply the best possible products at all times. For this reason, General Electric reserves the right to make changes in its products, and to introduce new lamps or discontinue existing ones without notice.

## Lamp Drawings

NOTE: These drawings show the correct bulb and base configurations, but not necessarily the correct filament, filament support, dimensions, or lead orientation.

See Table of Lamp Specifications for dimensions.

Drawings not to scale.



# Index — Miniature Lamps

Order Code			Lamp No.	Bulb	Base	Design		Mean Spherical Candlepower (Approx.)	Rated Average Lab Life (Hours)	Page No.	Line No.
Blister Pack	Unit Pack	Bulk Pack				Volts	Watts or Amps				
18462	25181	25183	<b>PR2</b>	B-3 1/2	S.C. Miniature Flanged	2.38	50A	0.80	15	25	3
18464	25193	25195	<b>PR3</b>	B-3 1/2	S.C. Miniature Flanged	3.57	50A	1.50	15	25	8
18466	25207		<b>PR4</b>	B-3 1/2	S.C. Miniature Flanged	2.33	27A	0.40	10	25	2
	25222		<b>PR6</b>	B-3 1/2	S.C. Miniature Flanged	2.47	30A	0.45	30	25	5
	25235		<b>PR7</b>	B-3 1/2	S.C. Miniature Flanged	3.7	30A	0.90	30	25	9
	25247		<b>PR9</b>	B-3 1/2	S.C. Miniature Flanged	2.7	15A	0.25	45	25	6
18467	25252	25254	<b>PR12</b>	B-3 1/2	S.C. Miniature Flanged	5.95	50A	0.50	15	25	15
18468	25262		<b>PR13</b>	B-3 1/2	S.C. Miniature Flanged	4.75	50A	2.20	15	25	13
	25279		<b>PR15</b>	B-3 1/2	S.C. Miniature Flanged	4.82	50A	1.90	30	25	14
	25289		<b>PR18</b>	B-3 1/2	S.C. Miniature Flanged	7.2	55A	5.50	3	25	16
	25295		<b>PR20</b>	B-3 1/2	S.C. Miniature Flanged	8.63	50A	5.00	15	25	17
18469	44778	44779	<b>PR30</b>	B-3 1/2	S.C. Miniature Flanged	3.75	86A	2.25	40	25	10
	13987		<b>PR37</b>	B-3 1/2	S.C. Miniature Flanged	2.45	1.2A	2.00	40	25	4
	15576		<b>KPR139</b>	B-3 1/2	S.C. Miniature Flanged	3.85	1.2A	5.10	15	25	11
		15579	<b>KPR140</b>	B-3 1/2	S.C. Miniature Flanged	4.0	0.9A	4.00	15	25	12
	15580	15581	<b>KPR141</b>	B-3 1/2	S.C. Miniature Flanged	2.0	1.2A	1.40	15	25	1
18130	20729		<b>H3-55*</b>	T-3 1/2	PK22S	12.0	55W	115.00	100	43	20
18131			<b>H3-100*</b>	T-3 1/2	PK22S	12.0	100W	187.00	50	43	21
18132	20731		<b>H4*</b>	T-5	P43T-38	12.0	60W/55W	—	100/200	45	1
	25299		<b>6</b>	S-8	D.C. Bayonet	6.4	3.0A	23.00	500	29	17
	12756		<b>6PSB</b>	T-2	Slide #5	6.0	14A	—	20000	36	19
	25312	25313	<b>10</b>	G-3 1/2	Miniature Two Pin	2.5	50A	0.50	3000	25	28
	28947		<b>10C5</b>	T-2	Tel. Slide #5	10.0	035-045A	0.06	10000	36	2
	25319	25321	<b>12</b>	G-3 1/2	Miniature Two Pin	6.3	15A	—	—	25	31
	28951		<b>12A1</b>	T-2	Tel. Slide #1	12.0	09-11A	0.30	7500	36	3
	12760		<b>12PSB</b>	T-2	Slide #5	12.0	17A	—	12000	36	20
	25331	25333	<b>13</b>	G-3 1/2	Miniature Screw	3.7	30A	0.98	15	25	30
18470	25354	25356	<b>14</b>	G-3 1/2	Miniature Screw	2.47	30A	0.50	15	25	27
	25371	25372	<b>15</b>	G-4 1/2	Miniature Two Pin	7.0	40A	2.00	500	26	18
	43604	43605	<b>18</b>	T-1 3/4	Wedge	14.0	04A	0.13	5000	34	16
	12070		<b>18ESB</b>	T-2	Slide #5	18.0	04A	—	18000	36	21
	25377	25379	<b>19</b>	G-3 1/2	Miniature Two Pin	14.4	10A	0.90	1000	26	3
	28990		<b>24B1</b>	T-2	Tel. Slide #1	24.0	035-045A	0.20	5000	36	4
	28995		<b>24D1</b>	T-2	Tel. Slide #1	24.0	09-11A	0.70	5000	36	5
	36600		<b>24EX</b>	T-2	Tel. Slide #1	24.0	032-038A	0.20	5000	36	8
	28999		<b>24E1</b>	T-2	Tel. Slide #1	24.0	032-038A	0.20	5000	36	6
	29003		<b>24F5</b>	T-2	Tel. Slide #5	24.0	032-038A	0.17	5000	36	7
	12071		<b>24PSB</b>	T-2	Slide #5	24.0	073A	—	10000	36	22
	29004		<b>24X</b>	T-2	Special #2	24.0	032-038A	—	10000	36	9
	17853		<b>24*</b>	T-2 3/4	Wedge	14.0	24A	2.00	1500	37	23
	17854		<b>24NA*</b>	T-2 3/4	Wedge	14.0	24A	1.50	1500	37	24
		11601	<b>P25-1</b>	S-8	S.C. Bayonet	13.5	1.86A	36.60	250	31	7
		11604	<b>P25-2</b>	S-8	D.C. Index	13.5	1.86A	35.00	250	31	8
						13.5	44A	2.78	1000		
	25388		<b>27</b>	G-4 1/2	Miniature Screw	4.9	30A	1.40	30	26	12
	12761		<b>28MB</b>	T-2 1/2	Miniature Bayonet	28.0	04A	0.29	5000	37	14
	12072		<b>28PSB</b>	T-2	Slide #5	28.0	04A	—	5000	36	23
	29015		<b>35A1</b>	T-2	Tel. Slide #1	35.0	035-045A	0.55	3000	36	10
	29016		<b>35A2</b>	T-2	Tel. Slide #2	35.0	035-045A	0.55	3000	36	11



# Index — Miniature Lamps

Order Code			Lamp No.	Bulb	Base	Design		Mean Spherical Candlepower (Approx.)	Rated Average Lab Life (Hours)	Page No.	Line No.
Blister Pack	Unit Pack	Bulk Pack				Volts	Watts or Amps				
	39220	13689	<b>37</b>	T-1 $\frac{3}{4}$	Wedge	14.0	.09A	0.50	2500	35	6
	25420	25422	<b>40</b>	T-3 $\frac{1}{4}$	Miniature Screw	6.3	.15A	0.52	3000	40	17
	25442	25444	<b>43</b>	T-3 $\frac{1}{4}$	Miniature Bayonet	2.5	.50A	0.50	3000	40	4
	25450	25466	<b>44</b>	T-3 $\frac{1}{4}$	Miniature Bayonet	6.3	.25A	0.90	3000	40	23
	25485	25504	<b>47</b>	T-3 $\frac{1}{4}$	Miniature Bayonet	6.3	.15A	0.52	3000	40	18
	29040		<b>48C1</b>	T-2	Tel. Slide #1	48.0	.032-.038A	0.40	5000	36	12
	29041		<b>48C2</b>	T-2	Tel. Slide #2	48.0	.032-.038A	0.40	5000	36	13
	29045		<b>48D1</b>	T-2	Tel. Slide #1	48.0	.017-.025A	0.12	15000	36	14
	29047		<b>48D2</b>	T-2	Tel. Slide #2	48.0	.017-.025A	0.12	15000	36	15
	12073		<b>48ESB</b>	T-2	Slide #5	48.0	.04A	—	5000	36	24
	12075		<b>48PSB</b>	T-2	Slide #5	48.0	.05A	—	10000	36	25
	25511		<b>49</b>	T-3 $\frac{1}{4}$	Miniature Bayonet	2.0	.06A	0.04	1000	40	2
	25529		<b>51</b>	G-3 $\frac{1}{2}$	Miniature Bayonet	7.5	.22A	1.00	1000	26	1
18551	25550	25552	<b>53</b>	G-3 $\frac{1}{2}$	Miniature Bayonet	14.4	.12A	1.00	1000	26	4
	25571	25573	<b>53X</b>	G-3 $\frac{1}{2}$	Miniature Bayonet	14.4	.12A	0.75	1000	26	5
	25576	25578	<b>55</b>	G-4 $\frac{1}{2}$	Miniature Bayonet	7.0	.41A	2.00	500	26	19
	29054		<b>55C1</b>	T-2	Tel. Slide #1	55.0	.045-.06A	1.10	5000	36	16
	29056		<b>55C2</b>	T-2	Tel. Slide #2	55.0	.045-.06A	1.10	5000	36	17
	42403		<b>56X</b>	T-1 $\frac{3}{4}$	Wedge	5.0	.115A	0.15	20000	34	3
	25591	25593	<b>57</b>	G-4 $\frac{1}{2}$	Miniature Bayonet	14.0	.24A	2.00	500	26	20
	25597		<b>57X</b>	G-4 $\frac{1}{2}$	Miniature Bayonet	14.0	.24A	2.00	500	26	21
	29062		<b>60A1</b>	T-2	Tel. Slide #1	60.0	.045-.055A	1.20	5000	36	18
	12076		<b>60MB</b>	T-2 $\frac{1}{2}$	Miniature Bayonet	60.0	.05A	0.73	7500	37	15
	12077		<b>60PSB</b>	T-2	Slide #5	60.0	.05A	—	7500	36	26
18471	25628	25630	<b>63</b>	G-6	S.C. Bayonet	7.0	.63A	3.00	1000	27	7
	25643		<b>64</b>	G-6	D.C. Bayonet	7.0	.63A	3.00	1000	27	8
18553	25652	25654	<b>67</b>	G-6	S.C. Bayonet	13.5	.59A	4.00	5000	27	12
	25692	25694	<b>68</b>	G-6	D.C. Bayonet	13.5	.59A	4.00	5000	27	13
	43606	43607	<b>70</b>	T-1 $\frac{3}{4}$	Wedge	14.0	.15A	1.50	100	35	9
	39218	39219	<b>73</b>	T-1 $\frac{3}{4}$	Wedge	14.0	.08A	0.30	15000	35	4
		41559	<b>73E</b>	T-1 $\frac{3}{4}$	Wedge, Wire Terminal	14.0	.08A	0.30	15000	35	5
	38457	38458	<b>74</b>	T-1 $\frac{3}{4}$	Wedge	14.0	.10A	0.70	1000	35	8
	42401		<b>79</b>	T-1 $\frac{3}{4}$	Wedge	6.0	.20A	0.60	1000	34	7
	25736		<b>81</b>	G-6	S.C. Bayonet	6.5	1.02A	6.00	500	27	5
	25751		<b>82</b>	G-6	D.C. Bayonet	6.5	1.02A	6.00	500	27	6
	40965		<b>84</b>	T-1 $\frac{3}{4}$	Wedge	28.0	.04A	0.03	20000	34	8
	40969	40970	<b>85</b>	T-1 $\frac{3}{4}$	Wedge	28.0	.04A	0.30	7000	35	23
	40967	40968	<b>86</b>	T-1 $\frac{3}{4}$	Wedge	6.3	.20A	0.40	20000	34	12
	25772		<b>88</b>	S-8	D.C. Bayonet	6.8	1.91A	15.00	300	29	25
18472	25778	25780	<b>89</b>	G-6	S.C. Bayonet	13.0	.58A	6.00	750	27	9
18473	25794	25796	<b>90</b>	G-6	D.C. Bayonet	13.0	.58A	6.00	750	27	10
	25811	25813	<b>93</b>	S-8	S.C. Bayonet	12.8	1.04A	15.00	700	30	1
	25829	25831	<b>94</b>	S-8	D.C. Bayonet	12.8	1.04A	15.00	700	30	2
18474	25836	25838	<b>97</b>	G-6	S.C. Bayonet	13.5	.69A	4.00	5000	27	15
	34121		<b>97A</b>	G-6	S.C. Bayonet	13.5	.69A	—	5000	27	16
	16287	16286	<b>98</b>	G-6	S.C. Bayonet	13.0	.62A	6.00	800	27	11
	36147	36148	<b>105</b>	B-6	S.C. Bayonet	12.8	1.00A	12.00	500	25	22
	25848		<b>112</b>	TL-3	Miniature Screw	1.2	.22A	—	5	39	16
	12078		<b>120MB</b>	T-2 $\frac{1}{2}$	Miniature Bayonet	120.0	.025A	0.36	10000	27	16



# Index — Miniature Lamps

Order Code			Lamp No.	Bulb	Base	Design		Mean Spherical Candlepower (Approx.)	Rated Average Lab Life (Hours)	Page No.	Line No.
Blister Pack	Unit Pack	Bulk Pack				Volts	Watts or Amps				
	12079		<b>120PS</b>	T-2	Wire Terminal	120.0	.025A	—	10000	36	27
	12080		<b>120PSB</b>	T-2	Slide #5	120.0	.025A	—	10000	36	28
		15556	<b>124</b>	T-3 <sup>1</sup> / <sub>4</sub>	Wedge	14.0	.27A	1.50	5000	42	9
	44767	44797	<b>127</b>	T-3 <sup>1</sup> / <sub>4</sub>	Wedge	2.47	.275A	0.48	30	40	3
	25897		<b>131</b>	G-3 <sup>1</sup> / <sub>2</sub>	Miniature Screw	1.3	.10A	0.03	50	25	25
	25916	25917	<b>147</b>	T-3 <sup>1</sup> / <sub>4</sub>	Wedge	7.0	.43A	2.00	1500	40	26
		14695	<b>148</b>	T-3 <sup>1</sup> / <sub>4</sub>	Wedge	7.0	.63A	2.00	200	40	27
		15731	<b>149</b>	T-3 <sup>1</sup> / <sub>4</sub>	Wedge	6.15	.53A	3.50	15	40	11
	25927		<b>157</b>	G-6	Miniature Screw	5.8	1.10A	8.10	50	27	4
	25931	25933	<b>158</b>	T-3 <sup>1</sup> / <sub>4</sub>	Wedge	14.0	.24A	2.00	500	42	7
		18054	<b>PC158*</b>	T-3 <sup>1</sup> / <sub>4</sub>	PC Socket	14.0	.24A	2.00	500	42	8
	25941	25942	<b>159</b>	T-3 <sup>1</sup> / <sub>4</sub>	Wedge	6.3	.15A	0.34	5000	40	15
	25956	25949	<b>161</b>	T-3 <sup>1</sup> / <sub>4</sub>	Wedge	14.0	.19A	1.00	4000	41	20
	17580	17001	<b>PC161*</b>	T-3 <sup>1</sup> / <sub>4</sub>	PC Socket	14.0	.19A	1.00	4000	42	1
		20273	<b>161B*</b>	T-3 <sup>1</sup> / <sub>4</sub>	Wedge	14.0	.19A	—	4000	42	2
		20274	<b>161B2*</b>	T-3 <sup>1</sup> / <sub>4</sub>	Wedge	14.0	.19A	—	4000	42	3
18475	25962	32668	<b>168</b>	T-3 <sup>1</sup> / <sub>4</sub>	Wedge	14.0	.35A	3.00	1500	42	27
	17578	17004	<b>PC168*</b>	T-3 <sup>1</sup> / <sub>4</sub>	PC Socket	14.0	.35A	3.00	1500	42	28
		20272	<b>PC168B*</b>	T-3 <sup>1</sup> / <sub>4</sub>	PC Socket	14.0	.35A	—	1500	42	29
	39011	39012	<b>192</b>	T-3 <sup>1</sup> / <sub>4</sub>	Wedge	13.0	.33A	3.00	1000	41	17
	19553	19852	<b>193*</b>	T-3 <sup>1</sup> / <sub>4</sub>	Wedge	14.0	.33A	2.00	15000	42	24
		19921	<b>193E*</b>	T-3 <sup>1</sup> / <sub>4</sub>	Wedge	14.0	.33A	2.00	15000	42	25
		14968	<b>193E-1</b>	T-3 <sup>1</sup> / <sub>4</sub>	Wedge, Wire Terminal	14.0	.33A	2.00	7500	42	26
18476	25965	25966	<b>194</b>	T-3 <sup>1</sup> / <sub>4</sub>	Wedge	14.0	.27A	2.00	2500	42	10
	17577	16999	<b>PC194*</b>	T-3 <sup>1</sup> / <sub>4</sub>	PC Socket	14.0	.27A	2.00	2500	42	11
18477	33591		<b>194A</b>	T-3 <sup>1</sup> / <sub>4</sub>	Wedge	14.0	.27A	—	2500	42	17
		20268	<b>PC194B*</b>	T-3 <sup>1</sup> / <sub>4</sub>	PC Socket	14.0	.27A	—	2500	42	12
		20275	<b>PC194B3*</b>	T-3 <sup>1</sup> / <sub>4</sub>	PC Socket	14.0	.27A	—	2500	42	15
		47862	<b>194E</b>	T-3 <sup>1</sup> / <sub>4</sub>	Wedge, Wire Terminal	14.0	.27A	2.00	2500	42	18
		44799	<b>194E-1</b>	T-3 <sup>1</sup> / <sub>4</sub>	Wedge, Wire Terminal	14.0	.27A	2.00	2500	42	19
		20269	<b>PC194G*</b>	T-3 <sup>1</sup> / <sub>4</sub>	PC Socket	14.0	.27A	—	2500	42	13
	44859	44860	<b>194NA</b>	T-3 <sup>1</sup> / <sub>4</sub>	Wedge	14.0	.27A	1.50	2500	42	16
		20270	<b>PC194R*</b>	T-3 <sup>1</sup> / <sub>4</sub>	PC Socket	14.0	.27A	—	2500	42	14
	37983	37984	<b>198</b>	S-8	D.C. Index	12.8	2.25A	32.00	1200	31	5
						14.0	.59A	3.00	5000		
	37985	37986	<b>199</b>	S-8	S.C. Bayonet	12.8	2.25A	32.00	1200	31	6
	25988		<b>210</b>	B-6	D.C. Bayonet	6.5	1.78A	15.00	100	25	19
18479	39224	39225	<b>211-2</b>	T-3	Miniature Cap	12.8	.97A	12.00	1000	39	1
	39222	39223	<b>212-2</b>	T-3	Miniature Cap	13.5	.74A	6.00	2000	39	6
	39356	39357	<b>214-2</b>	T-3	Miniature Cap	13.5	.52A	4.00	1000	39	5
18480	26008	26010	<b>222</b>	TL-3	Miniature Screw	2.25	.25A	—	5	39	17
	26052		<b>238</b>	T-3 <sup>1</sup> / <sub>4</sub>	Miniature Bayonet	6.3	.50A	2.00	2000	40	25
	26063	26065	<b>243</b>	TL-3	Miniature Screw	2.33	.27A	—	10	39	19
	26070		<b>245</b>	G-3 <sup>1</sup> / <sub>2</sub>	Miniature Screw	2.46	.50A	0.90	15	25	26
	28464		<b>251</b>	T-1 <sup>3</sup> / <sub>4</sub>	S.C. Midget Flanged	2.47	.30A	0.45	30	34	1
	28466		<b>252</b>	TL-1 <sup>1</sup> / <sub>2</sub>	S.C. Midget Flanged	2.5	.35A	—	10000	33	6
	28467		<b>253</b>	TL-1 <sup>1</sup> / <sub>2</sub>	Midget Grooved	2.5	.35A	—	10000	33	7
	28470	32420	<b>253X</b>	TL-1 <sup>1</sup> / <sub>2</sub>	Midget Grooved	2.5	.35A	—	10000	33	8



# Index — Miniature Lamps

Order Code			Lamp No.	Bulb	Base	Design		Mean Spherical Candlepower (Approx.)	Rated Average Lab Life (Hours)	Page No.	Line No.
Blister Pack	Unit Pack	Bulk Pack				Volts	Watts or Amps				
	26088		<b>257</b>	G-4½ FLASHER	Miniature Bayonet	14.0	.27A	1.60	500	26	23
	26095		<b>258</b>	G-4½ FLASHER	Miniature Screw	14.0	.27A	1.60	500	26	22
	26099	26100	<b>259</b>	T-3¼	Wedge	6.3	.25A	0.65	5000	40	21
	28475		<b>261</b>	TL-1½	Midget Grooved	2.5	.35A	—	10000	33	9
	44719		<b>265</b>	G-3½	Miniature Bayonet	28.0	.08A	0.75	5000	26	9
	42758	42759	<b>267</b>	T-3¼ FLASHER	Miniature Bayonet	6.3	.15A	0.33	5000	40	14
	28476		<b>268</b>	T-1¾	S.C. Midget Flanged	2.5	.35A	0.20	10000	34	2
	12151	12153	<b>280</b>	T-3¼	Wedge	10.0	.13A	0.85	250	40	29
	12155	12156	<b>285</b>	T-3¼	Wedge	5.0	.09A	0.25	1500	40	7
	32688	32689	<b>293</b>	G-4½	Miniature Bayonet	14.0	.33A	2.00	7500	26	26
	26112		<b>301</b>	G-5	S.C. Bayonet	28.0	.17A	3.00	500	27	2
	26120		<b>302</b>	G-5	D.C. Bayonet	28.0	.17A	3.00	500	27	3
	26127		<b>303</b>	G-6	S.C. Bayonet	28.0	.30A	6.00	500	27	21
	26136		<b>304</b>	G-6	D.C. Bayonet	28.0	.30A	6.00	500	27	22
	26143		<b>305</b>	S-8	S.C. Bayonet	28.0	.51A	15.00	300	31	10
	26145		<b>305AF</b>	S-8	S.C. Bayonet	28.0	.51A	—	300	31	11
	26152		<b>306</b>	S-8	D.C. Bayonet	28.0	.51A	15.00	300	31	12
	26157	26158	<b>307</b>	S-8	S.C. Bayonet	28.0	.67A	21.00	300	31	21
	26161		<b>307AF</b>	S-8	S.C. Bayonet	28.0	.67A	21.00	300	31	22
	26163		<b>307R</b>	S-8	S.C. Bayonet	28.0	.67A	—	300	31	23
	26166		<b>307SB</b>	S-8	S.C. Bayonet	28.0	.67A	—	300	31	24
	26168	26169	<b>308</b>	S-8	D.C. Bayonet	28.0	.67A	21.00	300	31	25
	26171	38908	<b>308AF</b>	S-8	D.C. Bayonet	28.0	.67A	—	300	31	26
	26175		<b>309</b>	S-11	S.C. Bayonet	28.0	.9A	32.00	300	32	12
	26177		<b>309AF</b>	S-11	S.C. Bayonet	28.0	.9A	—	300	32	13
	26183		<b>310</b>	S-11	D.C. Bayonet	28.0	.9A	32.00	300	32	14
	26191		<b>311</b>	S-11	S.C. Bayonet	28.0	1.29A	50.00	300	32	15
	26198		<b>311R</b>	S-11	S.C. Bayonet	28.0	1.29A	—	300	32	16
	26212	26214	<b>313</b>	T-3¼	Miniature Bayonet	28.0	.17A	3.50	500	43	13
	26238		<b>315</b>	S-8	S.C. Bayonet	28.0	.90A	32.00	300	31	32
	26243		<b>316</b>	T-3¼	Miniature Bayonet	6.0	.70A	3.40	500	40	10
	28504		<b>323</b>	T-1¼	Special	3.0	.19A	25.00	350	33	2
	28517		<b>325</b>	T-1¼	Special	3.0	.19A	25.00	350	33	1
	26519	28521	<b>327</b>	T-1¼	S.C. Midget Flanged	28.0	.04A	0.34	4000	35	12
	28541		<b>327AS-15</b>	T-1¼	S.C. Midget Flanged	28.0	.04A	0.34	4000	35	13
	28529		<b>327R</b>	T-1¼	S.C. Midget Flanged	28.0	.04A	—	4000	35	14
	28564		<b>328AS-10</b>	T-1¼	S.C. Midget Flanged	6.0	.20A	0.34	1000	34	6
	28546		<b>328</b>	T-1¼	S.C. Midget Flanged	6.0	.20A	0.34	1000	34	5
	28567		<b>330</b>	T-1¼	S.C. Midget Flanged	14.0	.08A	0.50	1500	34	17
	28588		<b>334</b>	T-1¼	Midget Grooved	28.0	.04A	0.34	4000	35	15
	28601		<b>335</b>	T-1¼	Midget Screw	28.0	.04A	0.34	4000	35	18
	28605		<b>336</b>	T-1¼	Midget Grooved	14.0	.08A	0.50	1500	35	1
	28621		<b>344</b>	T-1¼	S.C. Midget Flanged	10.0	.014A	0.006	50000	34	14
	28623		<b>345</b>	T-1¼	S.C. Midget Flanged	6.0	.04A	0.04	10000	34	4
	34231		<b>352X</b>	G-3½	Miniature Screw	3.0	.07A	0.15	50	25	29



# Index — Miniature Lamps

Order Code			Lamp No.	Bulb	Base	Design		Mean Spherical Candlepower (Approx.)	Rated Average Lab Life (Hours)	Page No.	Line No.
Blister Pack	Unit Pack	Bulk Pack				Volts	Watts or Amps				
	26255	26257	<b>356</b>	G-3½	Miniature Bayonet	28.0	.17A	3.50	500	26	10
	28641		<b>370</b>	T-1¼	S.C. Midget Flanged	18.0	.04A	0.15	10000	35	10
	26287		<b>378</b>	T-1¼	Midget Screw	6.3	.20A	0.40	20000	34	10
	28653		<b>381</b>	T-1¼	S.C. Midget Flanged	6.3	.20A	0.40	20000	34	11
	28657		<b>382</b>	T-1¼	S.C. Midget Flanged	14.0	.08A	0.30	40000	35	3
	28660		<b>385</b>	T-1¼	S.C. Midget Flanged	28.0	.04A	0.15	10000	35	24
	28662	28663	<b>386</b>	T-1¼	Midget Grooved	14.0	.08A	0.30	40000	35	2
	28664	28665	<b>387</b>	T-1¼	S.C. Midget Flanged	28.0	.04A	0.30	7000	35	20
	28672		<b>388</b>	T-1¼	Midget Grooved	28.0	.04A	0.30	7000	35	21
	28675		<b>394</b>	T-1¼	S.C. Midget Flanged	12.0	.04A	0.10	10000	34	15
	34230		<b>395X</b>	B-3½	S.C. Miniature Flanged	3.0	.07A	0.15	50	25	7
	38918	38919	<b>400</b>	T-3¼	Wedge	28.0	.10A	1.60	1000	43	12
	26324	26326	<b>407</b>	G-4½	Miniature Screw	4.9	.30A	1.20	50	26	11
					FLASHER					46	1
	26354	26356	<b>425</b>	G-4½	Miniature Screw	5.0	.50A	2.30	15	26	13
	47784	47785	<b>447</b>	T-3¼	Wedge	6.3	.15A	0.52	1500	40	19
	26436	26438	<b>455</b>	G-4½	Miniature Bayonet	6.5	.50A	1.90	500	26	17
					FLASHER					46	3
	26441	26442	<b>456</b>	G-4½	Miniature Bayonet	28.0	.17A	2.00	5000	26	27
	39645	39646	<b>464</b>	T-3¼	Wedge	28.0	.17A	3.00	1500	43	15
	26460	26462	<b>502</b>	G-4½	Miniature Screw	5.1	.15A	0.60	100	26	14
	26469		<b>503</b>	G-4½	Miniature Bayonet	5.1	.15A	0.60	100	26	15
	26485		<b>509K</b>	G-6	Candelabra Screw	24.0	.18A	2.80	1000	27	18
	44773	44774	<b>555</b>	T-3¼	Wedge	6.3	.25A	0.90	3000	40	22
	38269	38270	<b>558</b>	T-3¼	Wedge	13.0	.33A	—	500	41	16
18481	39746	40023	<b>561</b>	T-3	Rigid Loop	12.8	.97A	12.00	1000	39	2
	39745	40024	<b>562</b>	T-3	Rigid Loop	13.5	.74A	6.00	2000	39	7
		40025	<b>563</b>	T-3	Rigid Loop	13.5	.52A	4.00	1000	39	4
18531			<b>570*</b>	T3¼	Rigid Loop	12.8	2.10A	32.00	600	44	9
	20241		<b>577*</b>	T4¼	Double End Cap	12.8	1.40A	21.00	1000	44	10
	49936		<b>585</b>	T-3¼	Wedge	28.0	.04A	0.30	7000	43	6
	26549	26551	<b>605</b>	G-4½	Miniature Screw	6.15	.50A	3.40	15	26	16
	36935		<b>612</b>	G-3½	Miniature Two Pin	6.3	.25A	0.65	5000	25	32
	26561	26563	<b>623</b>	G-6	S.C. Bayonet	28.0	.37A	6.00	1000	27	23
	26567	26568	<b>624</b>	G-6	D.C. Bayonet	28.0	.37A	6.00	1000	27	24
	26570	26572	<b>631</b>	G-6	S.C. Bayonet	14.0	.63A	6.00	1000	27	17
		17718	<b>640*</b>	G-4½	Miniature Screw	14.0	.27A	2.00	2000	42	20
	38866	38867	<b>656</b>	T-3¼	Wedge	28.0	.06A	0.62	2500	43	7
	38196		<b>657</b>	T-3¼	Wedge	28.0	.08A	0.62	15000	43	10
	39999	40000	<b>658</b>	T-3¼	Wedge	14.0	.08A	0.31	15000	41	19
	18414	18415	<b>659*</b>	T-3¼	Wedge	14.0	.27A	2.00	2000	42	21
		28683	<b>680</b>	T-1	Wire Terminal	5.0	.06A	0.03	60000	32	18
	28691		<b>683</b>	T-1	Wire Terminal	5.0	.06A	0.05	40000	32	19
		28706	<b>685</b>	T-1	Sub-Midget Flanged	5.0	.06A	0.05	40000	32	20
	43132		<b>705</b>	S-8	S.C. Bayonet	28.0	.51A	15.00	900	31	13
		32335	<b>715</b>	T-1	Wire Terminal	5.0	.115A	0.15	40000	32	21
	28727		<b>718AS15</b>	T-1	Sub-Midget Flanged	5.0	.115A	0.15	40000	32	22
	26591	26592	<b>755</b>	T-3¼	Miniature Bayonet	6.3	.15A	0.33	20000	40	13
	26593	26594	<b>756</b>	T-3¼	Miniature Bayonet	14.0	.08A	0.31	15000	41	18



# Index — Miniature Lamps

Order Code			Lamp No.	Bulb	Base	Design		Mean Spherical Candlepower (Approx.)	Rated Average Lab Life (Hours)	Page No.
Blister Pack	Unit Pack	Bulk Pack				Volts	Watts or Amps			
	26599	26600	<b>757</b>	T-3 1/4	Miniature Bayonet	28.0	.08A	0.62	15000	43
	11014		<b>767</b>	T-2 1/4	Miniature Bayonet	6.0	12W	19.00	50	37
	11250	11251	<b>773</b>	T-2 1/4	G-4 Two Pin	12.0	8W	10.00	1000	37
	12723	12724	<b>774</b>	T-2 1/4	G-4 Two Pin	12.0	8W	13.00	50	37
		47618	<b>777</b>	T-2 1/4	G-4 Two Pin	4.0	1.20A	—	275	37
	49718	49719	<b>778</b>	T-2 1/4	G-4 Two Pin	6.0	20W	32.00	100	37
	18344	18345	<b>780*</b>	T2 1/4	G-4 Two Pin	12.0	10W	12.00	2000	37
	44840	44841	<b>782</b>	T-2 1/4	G-4 Two Pin	12.0	20W	25.00	2000	37
	44500	44501	<b>783</b>	T-2 1/4	G-4 Two Pin	12.0	12W	22.00	50	37
	43760	43761	<b>784</b>	T-2 1/4	G-4 Two Pin	6.0	6W	9.00	50	37
	43762	43763	<b>785</b>	T-2 1/4	G-4 Two Pin	6.0	6W	13.00	50	37
	43764	43765	<b>786</b>	T-2 1/4	G-4 Two Pin	6.0	12W	19.00	50	37
	43115	43116	<b>787</b>	T-2 1/4	G-5 Two Pin	6.0	10W	16.00	100	37
	43117	43118	<b>788</b>	T-2 1/4	G-4 Two Pin	6.0	3.33A	32.00	100	37
	43119	43120	<b>789</b>	T-2 1/4	G-4 Two Pin	12.0	14W	22.00	200	37
	43121	43122	<b>790</b>	T-2 1/4	G-4 Two Pin	14.0	25W	42.00	200	37
	43123	43124	<b>791</b>	T-2 1/4	G-4 Two Pin	14.0	35W	61.00	200	37
	44610	44611	<b>794</b>	T-2 1/4	G-4 Two Pin	10.5	15.7W	15.00	5000	37
	20469		<b>795*</b>	T-4	S.C. Bayonet	12.8	50W	108.00	200	43
	26609		<b>809M*</b>	G-8	Min Screw	70.0	.12A	0.80	600	28
	12783	12785	<b>880</b>	T-3 1/4	Axial Plastic Prefocus	12.8	2.10A	43.00	300	41
	12843	12844	<b>881</b>	T-3 1/4	Right Angle Plastic Prefocus	12.8	2.10A	43.00	300	41
	13158	13161	<b>882</b>	T-2 1/4	Printed Circuit Socket	12.8	.35A	3.80	2000	37
	18167	16772	<b>882-X</b>	T-2 1/4	G-4 Two Pin	12.8	.35A	3.80	2000	37
	14072	14071	<b>884</b>	T-3 1/4	Axial Plastic	12.8	2.10A	43.00	300	41
	14774	14775	<b>885</b>	T-3 1/4	Axial, Plastic, Prefocus	12.8	3.90A	100.00	200	41
	20240	19354	<b>886*</b>	T-3 1/4	Right Angle Plastic	12.8	3.90A	100.00	200	41
	15244	15245	<b>889</b>	T-3 1/4	Right Angle Plastic	12.8	2.10A	43.00	300	41
	15226	15227	<b>890</b>	T-3 1/4	Axial, Plastic	12.8	2.10A	43.00	300	41
	15246	15248	<b>891</b>	T-2 1/4	G-4 Two Pin	12.8	.63A	11.00	300	37
	16481	16282	<b>892</b>	T-3 1/4	Axial Plastic Prefoc	12.8	1.25A	28.00	300	41
	20237	18688	<b>893*</b>	T-3 1/4	Axial Plastic	12.8	2.93A	75.00	200	41
	20238	18455	<b>894*</b>	T-3 1/4	Right Angle Plastic	12.8	2.93A	75.00	200	41
	20239	19962	<b>896*</b>	T-3 1/4	Right Angle Plastic	12.8	2.93A	75.00	200	41
	40462	40463	<b>904</b>	T-5	Wedge	13.5	.69A	4.00	5000	45
	40289	40290	<b>906</b>	T-5	Wedge	13.0	.69A	6.00	1000	45
	44754	44755	<b>908</b>	T-5	Wedge	6.0	1.50A	12.00	50	44
	44756	44757	<b>909</b>	T-5	Wedge	6.0	.62A	3.00	50	44
18482	40504	40505	<b>912</b>	T-5	Wedge	12.8	1.00A	12.00	1000	45
	44769	44770	<b>914</b>	T-5	Wedge	4.0	.90A	3.50	50	44
	44771	44772	<b>915</b>	T-5	Wedge	12.0	.75A	11.00	50	45
	16289	16288	<b>916</b>	T-5	Wedge	13.5	.54A	2.00	10000	45
	44800	44801	<b>917</b>	T-5	Wedge	12.8	1.20A	10.00	1200	45
	17837	17835	<b>918</b>	T-5	Wedge	12.8	.56A	6.50	500	45
18484	43374	43375	<b>921</b>	T-5	Wedge	12.8	1.40A	21.00	500	45
	13274	13275	<b>922</b>	T-5	Wedge	12.8	.98A	15.00	200	45
	16955	16957	<b>923</b>	T-5	Wedge	12.8	.91A	12.50	500	45
	13483	13484	<b>926</b>	T-5	Wedge	4.0	1.80A	7.50	50	44
	13485	13486	<b>927</b>	T-5	Wedge	6.0	1.20A	8.00	50	44



# Index — Miniature Lamps

Order Code			Lamp No.	Bulb	Base	Design		Mean Spherical Candlepower (Approx.)	Rated Average Lab Life (Hours)	Page No.	Line No.
Blister Pack	Unit Pack	Bulk Pack				Volts	Watts or Amps				
	16975	15285	<b>939</b>	T-5	Wedge	6.0	.90A	5.40	50	44	18
	37038		<b>947</b>	T-3 1/4	Miniature Bayonet	9.84	.50A	4.00	500	40	28
		26671	<b>957</b>	T-4 1/2	Miniature Bayonet	9.84	.50A	4.60	200	44	2
18485	26709	26711	<b>1003</b>	B-6	S.C. Bayonet	12.8	.94A	15.00	200	25	20
18486	26726	26728	<b>1004</b>	B-6	D.C. Bayonet	12.8	.94A	15.00	200	25	21
	26775		<b>1034</b>	S-8	D.C. Index	12.8	1.80A	32.00	200	30	9
						12.8	.59A	3.00	5000		
	26815		<b>1047</b>	RP-11	S.C. Bayonet	26.0	2.70A	105.00	300	28	13
	32147		<b>1062</b>	RP-11	D.C. Bayonet	40.0	.92A	50.00	100	28	14
	26838	26840	<b>1073</b>	S-8	S.C. Bayonet	12.8	1.80A	32.00	200	30	10
	26854	26856	<b>1076</b>	S-8	D.C. Bayonet	12.8	1.80A	32.00	200	30	11
	37169	37170	<b>1096</b>	S-8	D.C. Pf., (S)	6.0	4.50A	30.00	500	29	11
	26872		<b>1129</b>	S-8	S.C. Bayonet	6.4	2.63A	21.00	200	29	15
	26885		<b>1133</b>	RP-11	S.C. Bayonet	6.2	3.91A	32.00	200	28	10
18488	26903	26905	<b>1141</b>	S-8	S.C. Bayonet	12.8	1.44A	21.00	1000	30	6
	26917	26919	<b>1142</b>	S-8	D.C. Bayonet	12.8	1.44A	21.00	1000	30	7
	26945	26946	<b>1152</b>	S-8	D.C. Bayonet	12.8	1.34A	21.00	500	30	4
18490	26948		<b>1154</b>	S-8	D.C. Index	6.4	2.63A	21.00	200	29	16
						7.0	.75A	3.00	1000		
	26955	26957	<b>1155</b>	G-6	S.C. Bayonet	13.5	.59A	4.00	5000	27	14
18491	26960	26963	<b>1156</b>	S-8	S.C. Bayonet	12.8	2.10A	32.00	1200	30	12
	20248		<b>1156NA*</b>	S-8	S.C. Bayonet	12.8	2.10A	24.00	1200	30	13
18492	26969	18619	<b>1157</b>	S-8	D.C. Index	12.8	2.10A	32.00	1200	30	22
						14.0	.59A	3.00	5000		
18495	26983		<b>1157A</b>	S-8	D.C. Index	12.8	2.10A	—	1200	30	23
						14.0	.59A	—	5000		
18497	26975	26976	<b>1157NA</b>	S-8	D.C. Index	12.8	2.10A	24.00	1200	30	24
						14.0	.59A	2.20	5000		
	27004		<b>1176</b>	S-8	D.C. Bayonet	12.8	1.34A	21.00	300	30	5
						14.0	.59A	6.00	1500		
	27021	27023	<b>1195</b>	RP-11	S.C. Bayonet	12.5	3.00A	50.00	300	28	11
	27026		<b>1196</b>	RP-11	D.C. Bayonet	12.5	3.00A	50.00	300	28	12
	27032	27033	<b>1203</b>	S-8	S.C. Bayonet	28.0	.71A	21.00	400	31	27
	27040		<b>1209</b>	RP-11	S.C. Pf. (B)	6.1	4.10A	32.00	125	28	9
	27044		<b>1224</b>	G-6	D.C. Bayonet	34.0	.16A	3.80	500	27	25
	39904		<b>1229</b>	S-8	D.C. Bayonet	40.0	.38A	15.00	400	32	6
	27081		<b>1240</b>	G-16 1/2	D.C. Pf. (A)	32.0	3.60A	250.00	35	28	2
	27092	27093	<b>1251</b>	G-6	S.C. Bayonet	28.0	.23A	3.00	2000	27	19
	27097		<b>1252</b>	G-6	D.C. Bayonet	28.0	.23A	3.00	2000	27	20
	12088		<b>SE1274</b>	T-1 3/4	BA 7.5mm	12.0	1.5W	1.00	500	47	17
	27116		<b>1302</b>	T-3 1/4	Miniature Bayonet	6.3	.04A	0.08	5000	40	12
	12824	12101	<b>1308</b>	B-6	S.C. Bayonet	28.0	.56A	16.00	2000	25	24
	27118	27119	<b>1309</b>	B-6	S.C. Bayonet	28.0	.52A	15.00	300	25	23
	32098		<b>1315</b>	G-5	S.C. Bayonet	2.5	1.00A	1.75	20	27	1
	34265	34266	<b>1317</b>	B-6	S.C. Bayonet	6.0	.51A	3.40	100	25	18
	27150		<b>1383</b>	R-12	S.C. Bayonet	13.0	20W	—	300	28	3
	27154	27155	<b>1385</b>	R-12	S.C. Bayonet	28.0	20W	—	300	28	5
	27159		<b>1388</b>	R-12	D.C. Bayonet	24.0	20W	—	500	28	4
	42572		<b>1392</b>	T-3	Two Pin Reflector	6.0	20.4W	10.00	10000	38	4
	27179	27180	<b>1408</b>	T-3 1/4	Miniature Bayonet	10.0	.13A	0.85	250	41	1



# Index — Miniature Lamps

Order Code			Lamp No.	Bulb	Base	Design		Mean Spherical Candlepower (Approx.)	Rated Average Lab Life (Hours)	Page No.	Line No.
Blister Pack	Unit Pack	Bulk Pack				Volts	Watts or Amps				
	27181		<b>1414</b>	T-4 1/2	Miniature Bayonet	12.0	.46A	6.00	500	44	4
	38914		<b>1416</b>	T-4 1/2	Miniature Bayonet	12.8	.80A	8.00	1000	44	3
	37813		<b>1424</b>	S-6	S.C. Bayonet	3.7	2.75A	11.00	100	29	3
	27913	27194	<b>1434</b>	T-5	S.C. Bayonet	3.7	2.75A	11.00	100	44	13
	11865		<b>1440</b>	S-6	D.C. Index	4.0	4.00A	20.00	50	29	4
						4.0	1.00A	3.70	275		
18499	27207	27209	<b>1445</b>	G-3 1/2	Miniature Bayonet	14.0	.135A	0.70	2000	26	6
	27234		<b>1447</b>	G-3 1/2	Miniature Screw	18.0	.15A	1.50	250	26	7
	27252		<b>1449</b>	G-3 1/2	Miniature Screw	14.0	.20A	2.00	250	26	2
	27263	27264	<b>1450</b>	G-3 1/2	Miniature Bayonet	24.0	.035A	0.23	3000	26	8
	28310	28311	<b>1460</b>	S-8	D.C. Pf. (A)	6.5	2.75A	23.00	100	29	18
	37342	37343	<b>1460X</b>	S-8	D.C. Pf. (A)	6.5	2.75A	23.00	100	29	19
	27305	27306	<b>1468</b>	S-8	D.C. Pf. (S)	6.0	4.50A	30.00	500	29	12
	42677	42678	<b>1468X</b>	S-8	D.C. Pf. (S)	6.0	4.50A	30.00	500	29	13
	27356		<b>1487</b>	T-3 1/4	Miniature Screw	14.0	.20A	1.40	3000	42	4
	27369		<b>1489</b>	T-5	S.C. Bayonet	6.5	2.75A	24.00	125	44	21
	27374		<b>1490</b>	T-3 1/4	Miniature Bayonet	3.2	.16A	0.20	3000	40	5
	27382	27384	<b>1493</b>	S-8	D.C. Bayonet	6.5	2.75A	23.00	100	29	20
	27392		<b>1495</b>	T-4 1/2	Miniature Bayonet	28.0	.30A	6.00	500	44	5
	44842	44843	<b>1495X</b>	T-4 1/2	Miniature Bayonet	28.0	.30A	6.00	500	44	6
	27410		<b>1503</b>	RP-11	S.C. Pf. (B)	5.9	6.53A	50.00	200	28	8
	47773		<b>1534</b>	S-6	D.C. Index	5.0	.55A	2.00	50	29	5
						28.0	.34A	6.00	1000		
	27431	27432	<b>1561</b>	S-11	S.C. Pf. (B)	6.3	4.00A	24.00	1500	32	9
		38249	<b>1563</b>	S-8	S.C. Bayonet	28.0	.76A	21.00	1000	31	29
	27434		<b>1565</b>	S-8	S.C. Pf. (S)	5.1	1.75A	4.80	5000	29	7
		49760	<b>1580X</b>	S-8	S.C. Bayonet	28.0	.93A	32.00	400	32	2
	40943	40944	<b>1591</b>	S-8	S.C. Bayonet	28.0	.61A	15.00	1000	31	14
	40945		<b>1591AF</b>	S-8	S.C. Bayonet	28.0	.61A	—	1000	31	15
	27439		<b>1594</b>	S-8	D.C. Bayonet	6.0	5.00A	36.00	250	29	14
	27461		<b>1612</b>	S-8	D.C. Bayonet	5.4	1.90A	10.00	1000	29	8
	27472		<b>1619</b>	S-8	S.C. Bayonet	6.7	1.90A	15.00	500	29	24
	27488	27489	<b>1630</b>	S-8	D.C. Pf. (A)	6.5	2.75A	23.00	100	29	21
	27491		<b>1631X</b>	S-8	D.C. Pf. (A)	6.5	2.75A	23.00	100	29	22
	27496		<b>1634</b>	S-8	D.C. Pf. (A)	20.0	1.00A	24.00	200	31	9
	27504		<b>1638</b>	S-8	D.C. Bayonet	28.0	1.02A	32.00	500	32	5
	27513		<b>1649</b>	S-8	D.C. Pf. (A)	6.5	2.75A	23.00	100	29	23
	27515		<b>1651</b>	S-8	S.C. Bayonet	5.0	.60A	3.00	20	29	6
	27529		<b>1662</b>	S-8	D.C. Index	28.0	.93A	32.00	400	32	3
						28.0	.34A	6.00	1000		
	27532	32405	<b>1665</b>	S-8	S.C. Bayonet	28.0	.80A	21.00	1000	31	30
	27533		<b>1665AF</b>	S-8	S.C. Bayonet	28.0	.80A	—	1000	31	31
	27548		<b>1680</b>	S-8	S.C. Bayonet	6.0	4.10A	32.00	300	29	9
	33995		<b>1680X</b>	S-8	S.C. Bayonet	6.0	4.10A	32.00	300	29	10
	27557	27559	<b>1683</b>	S-8	S.C. Bayonet	28.0	1.02A	32.00	500	32	4
	27566		<b>1691</b>	S-8	S.C. Bayonet	28.0	.61A	15.00	1000	31	16
	27568		<b>1691AF</b>	S-8	S.C. Bayonet	28.0	.61A	—	1000	31	17
	27571		<b>1692</b>	S-8	D.C. Bayonet	28.0	.61A	15.00	1000	31	18
	43819		<b>1726X</b>	S-11	D.C. Bayonet	12.5	3.00A	—	300	32	11
	27608		<b>1731</b>	S-11	S.C. Pf. (B)	6.3	6.60A	47.00	1000	32	10

# Index — Miniature Lamps

Order Code			Lamp No.	Bulb	Base	Design		Mean Spherical Candlepower (Approx.)	Rated Average Lab Life (Hours)	Page No.	Line No.
Blister Pack	Unit Pack	Bulk Pack				Volts	Watts or Amps				
	27627	27628	<b>1763</b>	S-11	S.C. Pf. (B)	6.1	4.10A	32.00	1500	32	8
		28764	<b>1764D</b>	T-1 $\frac{3}{4}$	Wire Terminal	28.0	.04A	0.34	4000	35	11
	27630		<b>1777</b>	S-8	S.C. Bayonet	12.8	1.52A	0.26	400	30	8
	27659	27660	<b>1810</b>	T-3 $\frac{1}{4}$	Miniature Bayonet	6.3	.40A	1.50	3000	40	24
	27667	27668	<b>1813</b>	T-3 $\frac{1}{4}$	Miniature Bayonet	14.4	.10A	0.86	1000	43	1
	27677	27679	<b>1815</b>	T-3 $\frac{1}{4}$	Miniature Bayonet	14.0	.20A	1.40	3000	42	5
	27688	27690	<b>1816</b>	T-3 $\frac{1}{4}$	Miniature Bayonet	13.0	.33A	3.00	1000	41	15
	27707		<b>1818</b>	T-3 $\frac{1}{4}$	Miniature Bayonet	24.0	.17A	3.30	250	43	3
	27711	27712	<b>1819</b>	T-3 $\frac{1}{4}$	Miniature Bayonet	28.0	.04A	0.34	2500	43	5
	27727	27728	<b>1820</b>	T-3 $\frac{1}{4}$	Miniature Bayonet	28.0	.10A	1.60	1000	43	11
	27749		<b>1822</b>	T-3 $\frac{1}{4}$	Miniature Bayonet	36.0	.10A	2.10	1000	43	17
	27772		<b>1828</b>	T-3 $\frac{1}{4}$	Miniature Bayonet	37.5	.05A	0.65	3000	43	18
	27776	27777	<b>1829</b>	T-3 $\frac{1}{4}$	Miniature Bayonet	28.0	.07A	1.00	1000	43	8
	27804	27805	<b>1835</b>	T-3 $\frac{1}{4}$	Miniature Bayonet	55.0	.05A	1.10	5000	43	19
	27816	27818	<b>1843</b>	T-3 $\frac{1}{4}$	Miniature Bayonet	28.0	.022A	0.20	3000	43	4
		41557	<b>1846</b>	T-3 $\frac{1}{4}$	Miniature Screw	0.8	.033A	—	—	40	1
	27819		<b>1847</b>	T-3 $\frac{1}{4}$	Miniature Bayonet	6.3	.15A	0.38	5000	40	16
	27833	27835	<b>1850</b>	T-3 $\frac{1}{4}$	Miniature Bayonet	5.0	.09A	0.25	1500	40	8
		38689	<b>1850W</b>	T-3 $\frac{1}{4}$	Miniature Bayonet	5.0	.09A	0.25	1500	40	9
	27862	27863	<b>1864</b>	T-3 $\frac{1}{4}$	Miniature Bayonet	28.0	.17A	3.50	1500	43	14
	27868		<b>1866</b>	T-3 $\frac{1}{4}$	Miniature Bayonet	6.3	.25A	0.65	5000	40	20
		28809	<b>1869D</b>	T-1 $\frac{3}{4}$	Wire Terminal	10.0	.14A	0.006	50000	34	13
	40383	40384	<b>1873</b>	T-3 $\frac{1}{4}$	Miniature Bayonet	28.0	.20A	3.00	7000	43	16
	27882		<b>1874</b>	T-5	S.C. Bayonet	3.7	2.75A	11.00	100	44	14
	27889	27890	<b>1876</b>	T-5	S.C. Bayonet	3.5	2.50A	6.50	2000	44	11
	36774		<b>1876X</b>	T-5	S.C. Bayonet	3.5	2.50A	6.50	2000	44	12
	27899		<b>1886</b>	T-4 $\frac{1}{2}$	Miniature Bayonet	6.3	.90A	4.20	3000	44	1
	27907		<b>1889</b>	T-3 $\frac{1}{4}$	Miniature Bayonet	14.0	.27A	2.00	2000	42	22
18545	27917	27919	<b>1891</b>	T-3 $\frac{1}{4}$	Miniature Bayonet	14.0	.24A	2.00	500	42	6
	27927	27929	<b>1892</b>	T-3 $\frac{1}{4}$	Miniature Bayonet	14.4	.12A	0.75	1000	43	2
18550	27935	27937	<b>1893</b>	T-3 $\frac{1}{4}$	Miniature Bayonet	14.0	.33A	2.00	7500	42	23
18500	27945	27948	<b>1895</b>	G-4 $\frac{1}{2}$	Miniature Bayonet	14.0	.27A	2.00	2000	26	24
		34508	<b>1895R</b>	G-4 $\frac{1}{2}$	Miniature Bayonet	14.0	.27A	—	2000	26	25
		34286	<b>1906</b>	T-3 $\frac{1}{4}$	Miniature Bayonet	5.0	.07A	0.19	1000	40	6
	34021		<b>1939X</b>	T-7	S.C. Bayonet	28.0	50W	70.00	300	45	15
	28008		<b>1940</b>	T-7	S.C. Bayonet	14.0	50W	75.00	300	45	12
	37034		<b>1944</b>	T-7	S.C. Bayonet	14.0	3.57A	75.00	300	45	13
	45087		<b>1944X</b>	T-7	S.C. Bayonet	14.0	3.57A	75.00	300	45	14
		41522	<b>1945</b>	T-4	Two Pin	32.0	200W	360.00	200	43	29
	18617		<b>1946*</b>	T-3	Wire Terminal	28.0	250W	660.00	50	39	15
		15953	<b>1956*</b>	T-3	Wire Terminal	28.0	200W	525.00	50	39	14
	28011		<b>1958</b>	T-4	Tab	28.0	150W	250.00	300	43	25
	35093		<b>1959</b>	T-4	Tab	28.0	150W	240.00	300	43	26
	28022		<b>1960</b>	T-4	Tab	11.0	60W	90.00	1000	43	23
	28024		<b>1962</b>	T-3	Wire Terminal	8.5	62W	110.00	50	38	6
	39641		<b>1962B</b>	T-3	Wire Terminal	8.5	62W	110.00	50	38	7
		12859	<b>1962BG*</b>	T-3	Wire Terminal	8.5	62W	110.00	50	38	11
		37947	<b>1962DX</b>	T-3	Wire Terminal	8.5	62W	80.00	150	38	9
	44152		<b>1962DZ</b>	T-3	Wire Terminal	8.5	62W	80.00	150	38	8



# Index — Miniature Lamps

Order Code			Lamp No.	Bulb	Base	Design		Mean Spherical Candlepower (Approx.)	Rated Average Lab Life (Hours)	Page No.	Line No.
Blister Pack	Unit Pack	Bulk Pack				Volts	Watts or Amps				
	13667		<b>1962TY</b>	T-3	Wire Terminal	8.5	.62W	110.00	50	38	10
	28028		<b>1964</b>	T-3	Special Sleeve	28.0	150W	230.00	1000	39	11
	28019		<b>1967</b>	T-3	Special Sleeve	28.0	150W	210.00	1000	39	10
	28034		<b>1968</b>	T-3	Double Slide	28.0	.25W	15.00	500	39	9
	28036		<b>1970</b>	T-3	Special Sleeve	28.0	100W	150.00	1000	39	12
	41938		<b>1970X</b>	T-3	Special Sleeve	28.0	100W	140.00	1000	39	13
	32780		<b>1974</b>	T-3	Wire Terminal	6.0	.20W	10.00	10000	38	3
	34093		<b>1975</b>	T-3	Double Slide	12.8	.25W	25.00	500	38	14
	34521		<b>1976</b>	T-3	Double Slide	13.0	.75W	115.00	400	39	3
	36429		<b>1977</b>	T-3	Double Slide	8.5	7.30A	110.00	50	38	5
	38545		<b>1978X</b>	T-3	Special	10.0	100W	130.00	2000	38	12
	38627		<b>1982</b>	T-3	S.C. Bayonet	28.0	.75W	110.00	1000	39	8
	39718		<b>1983</b>	T-4	Wire Terminal	10.0	10.00A	130.00	2000	43	22
	44717		<b>1986</b>	T-4	Wire Terminal	28.0	250W	600.00	100	43	28
	47965		<b>1987</b>	T-4	D.C. Bayonet	28.0	150W	240.00	700	43	27
	38535		<b>1988</b>	T-3	Special, Wire Leads	10.0	100W	130.00	2000	38	13
		13600	<b>2031*</b>	S-8	Wire Terminal	12.8	1.14A	21.00	500	30	3
	19280		<b>2040*</b>	T-2 1/4	Wedge	12.8	.625A	10.50	500	37	13
18501	44760	18620	<b>2057</b>	S-8	D.C. Index	12.8	2.10A	32.00	1200	30	14
						14.0	.48A	2.00	5000		
18505	44763	44764	<b>2057NA</b>	S-8	D.C. Index	12.8	2.10A	24.00	1200	30	15
						14.0	.48A	1.50	5000		
		12899	<b>2058U</b>	S-8	Wire Terminal	12.8	2.10A	32.00	1200	30	16
						14.0	.48A	2.00	5000		
	13493		<b>2075</b>	T-3	Double Slide	12.8	1.95A	10.50	500	38	15
		32506	<b>2112D</b>	T-1 3/4	Wire Terminal	6.3	.20A	0.55	10000	34	9
		35625	<b>2121D</b>	TL-3	Wire Terminal	2.25	.25A	—	5	39	18
		28839	<b>2124D</b>	TL-1 1/2	Wire Terminal	2.5	.35A	—	10000	33	5
		28085	<b>2144*</b>	S-8	Wire Terminal	12.8	2.10A	32.00	600	31	3
		32701	<b>2155*</b>	S-8	Wire Terminal	28.0	.93A	32.00	400	32	1
						28.0	.34A	6.00	1000		
		28111	<b>2162D</b>	T-1 3/4	Wire Terminal	14.0	.10A	0.50	10000	35	7
		28907	<b>2187D</b>	T-1 3/4	Wire Terminal	28.0	.04A	0.30	7000	35	19
	34763	34764	<b>2232</b>	S-8	S.C. Bayonet	28.0	.643A	18.00	2000	31	19
	43134		<b>2232SB</b>	S-8	S.C. Bayonet	28.0	.643A	—	2000	31	20
	36906	36907	<b>2233</b>	S-8	S.C. Bayonet	28.0	.766A	21.00	2000	31	28
		38988	<b>2242</b>	S-8	Wire Terminal	12.8	2.10A	32.00	1200	30	25
						14.0	.59A	3.00	5000		
		44964	<b>2286D</b>	T-3 1/4	Wire Terminal	14.0	.35A	2.70	1500	42	30
		36169	<b>2286U</b>	T-3 1/4	Wire Terminal	14.0	.35A	2.70	1500	42	31
	28100		<b>2331</b>	RP-11	D.C. Pf.(S)	5.9	4.66A	32.00	400	28	6
						6.2	4.49A	32.00	400		
		33411	<b>2338</b>	RP-11	D.C. Pf.(S)	5.9	4.66A	32.00	400	28	7
						6.2	4.49A	32.00	400		
18529	16291	16290	<b>2357</b>	S-8	D.C. Index	12.8	2.20A	40.00	400	31	1
						14.0	.59A	3.00	5000		
18530	15698	15699	<b>2357NA</b>	S-8	D.C. Index	12.8	2.20A	30.00	400	31	2
						14.0	.59A	2.20	5000		
	18047	18046	<b>2396*</b>	S-8	S.C. Bayonet	12.8	2.23A	40.00	400	31	4

# Index — Miniature Lamps

Order Code			Lamp No.	Bulb	Base	Design		Mean Spherical Candlepower (Approx.)	Rated Average Lab Life (Hours)	Page No.	Line No.
Blister Pack	Unit Pack	Bulk Pack				Volts	Watts or Amps				
		19567	<b>2576*</b>	S-6	Wire Terminal	3.5	2.50A	6.50	2500	29	1
	20246	19793	<b>2577*</b>	S-6	S.C. Bayonet	3.5	2.50A	6.50	2500	29	2
	40590	40591	<b>2600</b>	T-1 1/2	Wire Terminal	3.5	.72A	2.90	20	33	4
	40586	40587	<b>2601</b>	TL-1	Wire Terminal	3.5	2.5W	—	20	33	12
	43805	43806	<b>2604X</b>	TL-2 1/2	G-4 Two Pin	5.0	10W	—	5000	38	1
	45106		<b>2605</b>	TL-2 3/4	G-4 Two Pin	6.0	10W	—	100	38	2
		14924	<b>2759</b>	S-11	S.C. Pf.(B)	6.1	4.10A	35.00	125	32	7
	36508	36509	<b>3011</b>	S-11	S.C. Bayonet	28.0	1.29A	44.00	1000	32	17
	12086		<b>DE3021</b>	T-2 1/4	SV 7mm	12.0	3W	2.00	1000	47	16
18506	12082		<b>DE3022</b>	T-2 1/4	SV 7mm	12.0	5W	3.00	1000	47	12
		40144	<b>3026</b>	T-2	Wire Terminal	6.3	13.2W	17.50	75	36	1
19360	18389	18353	<b>3057*</b>	S-8	Plastic Wedge	12.8	2.10A	32.00	1200	30	20
						14.0	.59A	3.00	5000		
19361	18391	18358	<b>3057NA*</b>	S-8	Plastic Wedge	12.8	2.10A	24.00	1200	30	21
						14.0	.59A	2.00	5000		
		44865	<b>3133</b>	T-1 1/2	Wire Terminal	2.5	.80A	1.60	20	33	3
		44858	<b>3134</b>	TL-1 1/2	Wire Terminal	2.5	.80A	—	20	33	11
	20243		<b>3155*</b>	S-8	Plastic Wedge	12.8	1.60A	21.00	1500	30	17
19362	17172	18359	<b>3157*</b>	S-8	Plastic Wedge	12.8	2.10A	32.00	1200	30	18
						14.0	.48A	2.00	5000		
19363	17173	18360	<b>3157NA*</b>	S-8	Plastic Wedge	12.8	2.10A	24.00	1200	30	19
						14.0	.48A	1.50	5000		
18507	12084		<b>DE3175</b>	T-3 1/2	SV 8.5mm	12.0	10W	9.55	400	47	14
	12087		<b>DE3423</b>	T-4	SV 8.5mm	12.0	5W	4.00	150	47	13
	12085		<b>DE3425</b>	T-4	SV 8.5mm	12.0	10W	9.55	400	47	15
	28154		<b>5004CW</b>	T-5	Miniature Pinless	a.c.	4W	—	7500	46	9
	28155		<b>5004WW</b>	T-5	Miniature Pinless	a.c.	4W	—	7500	46	10
	28160		<b>5008CW</b>	T-5	Miniature Pinless	a.c.	8W	—	7500	46	13
	28163		<b>5008WW</b>	T-5	Miniature Pinless	a.c.	8W	—	7500	46	14
	28168		<b>5013CW</b>	T-5	Miniature Pinless	a.c.	13W	—	7500	46	16
	28169		<b>5013WW</b>	T-5	Miniature Pinless	a.c.	13W	—	7500	46	17
	28173		<b>5104WW</b>	T-5	Miniature Bi-Pin	a.c.	4W	—	7500	46	11
	33612		<b>5106WW</b>	T-5	Miniature Bi-Pin	a.c.	6W	—	7500	46	12
	28175		<b>5108WW</b>	T-5	Miniature Bi-Pin	a.c.	8W	—	7500	46	15
	28178		<b>5113WW</b>	T-5	Miniature Bi-Pin	a.c.	13W	—	7500	46	18
	28922		<b>7327</b>	T-1 3/4	Bi-Pin M-23	28.0	.04A	0.34	4000	35	16
	42564		<b>7378</b>	T-1 3/4	Bi-Pin M-23	28.0	.04A	0.34	4000	35	17
	28926		<b>7387</b>	T-1 3/4	Bi-Pin M-23	28.0	.04A	0.30	7000	35	22
		40584	<b>8261</b>	TL-1 1/2	Bi-Pin M-23	2.5	.35A	—	10000	33	10
		11284	<b>HR9000</b>	PAR-18	G-6 Two Pin	6.0	7W	—	50	46	6
		11286	<b>HR9001</b>	PAR-18	G-6 Two Pin	6.0	12W	—	50	46	7
		11289	<b>HR9002</b>	PAR-18	G-6 Two Pin	12.0	12W	—	50	46	8
18508		18699	<b>9004</b>	T-4 3/4	Axial Plastic, Prefocus	12.8	65W	138.00	150	44	7
						12.8	45W	85.00	320		
18509		17120	<b>9005</b>	T-3 1/4	Rt. Angle, Plastic, Prefocus	12.8	65W	135.00	150	41	14
18510		17121	<b>9006</b>	T-3 1/4	Rt. Angle, Plastic, Prefocus	12.8	55W	80.00	320	41	13
	20551	20552	<b>9007*</b>	T-4 3/4	Axial, Plastic, Prefocus	12.8	65W	—	150	44	8
							55W	—	320		
	12571		<b>ML20/OF-28</b>	T-8	Disk	28.0	20W	—	500	45	17
	28433		<b>ML20/R-28</b>	T-8	Disk	28.0	20W	—	500	45	16



## Index — Neon Glow Lamps

Order Code			Lamp No.	Bulb	Base	Design		Mean Spherical Candlepower (Approx.)	Rated Average Lab Life (Hours)	Page No.	Line No.
Blister Pack	Unit Pack	Bulk Pack				Volts	Watts or Amps				
	12063		<b>A1H</b>	T-2	S.C. Midget Flanged	105-125	.0012A	—	25000	47	1
	12064		<b>B1A</b>	T-3-1/4	Miniature Bayonet	105-125	.0003A	—	15000	47	4
	12065		<b>B2A</b>	T-3-1/4	Miniature Bayonet	105-125	.0012A	—	25000	47	5
	31675		<b>B7A</b>	T-4-1/2	Candelabra Screw	105-125	.002A	—	7500	47	6
	31679		<b>B9A</b>	T-4-1/2	D.C. Bayonet	105-125	.002A	—	7500	47	7
	12066		<b>C7A</b>	T-2	S.C. Midget Flanged	105-125	.0007A	—	25000	47	2
	12067		<b>C9A</b>	T-2	S.C. Midget Flanged	105-125	.0019A	—	25000	47	3
	31694		<b>F3A</b>	T-4-1/2	Candelabra Screw	105-125	.002A	—	7500	47	8
	31695		<b>F4A</b>	T-4-1/2	Candelabra Screw	210-250	.002A	—	7500	47	9
	31658		<b>J5A</b>	S-11	Medium Screw	105-125	.012A	—	10000	47	10
	31691		<b>J9A</b>	S-11	Medium Screw	210-250	.005A	—	10000	47	11

## Index — Sealed Beam Lamps

Order Code			Lamp No.	Bulb	Base	Design		Initial Max. Beam Candlepower (Approx.)	Rated Average Lab Life (Hours)	Page No.	Line No.
Blister Pack	Unit Pack	Bulk Pack				Volts	Watts or Amps				
	18511	37836	<b>4000</b>	PAR46	3 Contact Lugs	12.8/12.8	37.5W/60W	SAE	200/320	53	29
	18516	24231	<b>4001</b>	PAR46	2 Contact Lugs	12.8	37.5W	SAE	300	53	31
	24247		<b>4001R</b>	PAR46	2 Contact Lugs	12.8	37.5W	—	300	54	1
	24327	24325	<b>4013</b>	PAR46	Screw Terminals	6.4	25W	800	300	53	10
	24339	24338	<b>4014</b>	PAR36	Screw Terminals	6.4	18W	1500	200	50	24
	24369		<b>4019</b>	PAR46	Screw Terminals	6.2	30W	1200	300	53	9
	24372		<b>4020</b>	PAR46	3 Contact Lugs	6.4/6.4	30W/30W	SAE	300/300	53	12
	24392		<b>4031</b>	PAR46	3 Contact Lugs	6.4/6.4	45W/45W	SAE	300/500	53	13
	38418	40558	<b>4040</b>	PAR46	3 Contact Lugs	12.8/12.8	37.5W/60W	SAE	300/500	53	30
	39585	39586	<b>4042</b>	PAR36	Screw Terminals	6.4	12W	1100	150	50	23
	40588	40589	<b>4044</b>	PAR36	Screw Terminals	12.0	12W	1110	150	51	4
	10540	10541	<b>4044-1</b>	PAR36	Slip-on Terminals	12.0	12W	1110	150	51	5
	25039		<b>4308</b>	PAR36	3 Screw Terminals	6.4/6.4	25W/12W	24000/3000	300/150	50	27
	25051		<b>4313</b>	PAR36	Screw Terminals	13.0	250W	14000	25	52	25
	39366	39367	<b>4340</b>	PAR36	Screw Terminals	48.0	80W	2500	400	53	8
	39362	39363	<b>4350</b>	PAR36	Screw Terminals	36.0	60W	2100	400	53	7
	18347	18350	<b>H4360*</b>	140MM	2 Lugs, Rt. Angle	12.8	37.5W	2000	320	49	2
		18352	<b>H4362*</b>	140MM	2 Lugs, Rt. Angle	12.8	37.5W	—	640	49	1
	12961		<b>4402A</b>	PAR36	Screw Terminals	28.0	50W	1000	400	52	28
	24425	24423	<b>4405</b>	PAR36	Screw Terminals	12.8	30W	50000	100	51	13
	15129		<b>H4405</b>	PAR36	Screw Terminals	12.8	30W	66000	100	51	14
	24430	24428	<b>4406</b>	PAR36	Screw Terminals	12.8	35W	600	300	51	20
		36629	<b>4406-1</b>	PAR36	Slip-on Terminals	12.8	35W	600	300	51	21
	41239	41240	<b>4409X</b>	PAR36	Screw Terminals	12.8	35W	600	300	51	22
	24439	24440	<b>4410</b>	PAR36	Screw Terminals	12.8	35W	600	300	51	23
	24448	24443	<b>4411</b>	PAR36	Screw Terminals	12.8	35W	3000	300	51	24
	37889	37890	<b>4411-1</b>	PAR36	Slip-on Terminals	12.8	35W	3000	300	51	25
	24454	24453	<b>4412</b>	PAR46	Screw Terminals	12.8	35W	11000	300	53	18
	24460	24459	<b>4412A</b>	PAR46	Screw Terminals	12.8	35W	8800	300	53	19
	49815		<b>4412A-1</b>	PAR46	Slip-on Terminals	12.8	35W	8800	300	53	20

# Index — Sealed Beam Lamps

Order Code			Lamp No.	Bulb	Base	Design		Initial Max. Beam Candlepower (Approx.)	Rated Average Lab Life (Hours)	Page No.	Line No.
Blister Pack	Unit Pack	Bulk Pack				Volts	Watts or Amps				
	24466	24464	<b>4413</b>	PAR46	Screw Terminals	12.8	35W	1100	300	53	21
	24472		<b>4413R</b>	PAR46	Screw Terminals	12.8	35W	200	300	53	22
	24478	24477	<b>4414</b>	PAR36	Screw Terminals	12.8	18W	1500	300	51	7
		36305	<b>4414-1</b>	PAR36	Slip-on Terminals	12.8	18W	1500	300	51	8
	24483		<b>4414A</b>	PAR36	Screw Terminals	12.8	18W	450	300	51	9
	24487		<b>4414R</b>	PAR36	Screw Terminals	12.8	18W	275	300	51	10
	24493	24490	<b>4415</b>	PAR36	Screw Terminals	12.8	35W	9000	300	51	29
	24499	24497	<b>4415A</b>	PAR36	Screw Terminals	12.8	35W	7000	300	51	30
	24504	24503	<b>4416</b>	PAR36	Screw Terminals	12.8	30W	35000	300	51	15
		34901	<b>4416-1</b>	PAR36	Slip-on Terminals	12.8	30W	35000	300	51	16
	24506		<b>4416A</b>	PAR36	Screw Terminals	12.8	30W	26000	300	51	17
	24516		<b>4416B</b>	PAR36	Screw Terminals	12.8	30W	—	300	51	18
	24513		<b>4416R</b>	PAR36	Screw Terminals	12.8	30W	4000	300	51	19
	24531	24525	<b>4419</b>	PAR46	Screw Terminals	12.8	35W	1600	300	53	23
	24536		<b>4420</b>	PAR46	3 Contact Lugs	12.8/12.8	30W/30W	SAE	300/300	53	17
	24539	24541	<b>4421</b>	PAR46	Slip-on Terminals	13.0	100W	23000	300	54	16
	24542	24544	<b>4422</b>	PAR36	Screw Terminals	12.8	35W	600	300	51	26
	24551		<b>4425R</b>	PAR36	3 Screw Terminals	12.8/12.8	50W/18W	500/100	200/200	52	11
	24553		<b>4427</b>	PAR46	Screw Terminals	12.8	35W	1200	300	53	24
	24566		<b>4431</b>	PAR46	3 Contact Lugs	12.8/12.8	45W/35W	SAE	320/320	54	5
	24572		<b>4434A</b>	PAR46	Screw Terminals	12.8	40W	—	200/200	54	3
	24577	24576	<b>4435</b>	PAR46	Screw Terminals	12.8	30W	75000	100	53	16
	24582	24583	<b>4436</b>	PAR46	Screw Terminals	12.8	35W	60000	300	53	25
	35703		<b>4436R</b>	PAR46	Screw Terminals	12.8	35W	9000	300	53	26
	39744		<b>4439X</b>	PAR46	2 Contact Lugs	12.8	18W	900	300	53	15
	39932	39933	<b>4440X</b>	PAR36	3 Contact Lugs	12.8/12.8	40W/40W	6000/4500	320/320	52	2
	39748	39749	<b>4440X-1</b>	PAR36	3 Slip-on Terminals	12.8/12.8	40W/40W	6000/4500	320/320	52	3
	37046	37047	<b>4446</b>	PAR36	Screw Terminals	12.8	25W	400	300	51	12
	24589		<b>4459</b>	PAR46	3 Slip-on Terminals	12.8/12.8	40W/40W	1400/1300	320/320	54	4
	40176		<b>4460X</b>	PAR36	3 Screw Terminals	12.8/12.8	40W/40W	6500/5000	320/320	52	4
	17717	17674	<b>H4460X</b>	PAR36	3 Screw Terminals	12.8/12.8	60W/60W	11000/8500	320/320	52	17
	24592		<b>4461</b>	PAR36	Screw Terminals	12.8	60W	6000	300	52	12
	24606	33572	<b>4464</b>	PAR36	Screw Terminals	12.8	60W	50000	300	52	13
	24609		<b>4464R</b>	PAR36	Screw Terminals	12.8	60W	7000	300	52	14
	24596	24597	<b>4466</b>	PAR36	Screw Terminals	12.8	60W	1000	300	52	15
	42887	42888	<b>4467</b>	PAR46	3 Contact Lugs	12.8/12.8	50W/35W	SAE	320/275	54	13
	24613	24612	<b>4478</b>	PAR46	2 Contact Lugs	13.0	60W	1600	800	54	15
	39952		<b>4492</b>	PAR46	3 Contact Lugs	12.8/12.8	60W/60W	21000/19000	300/300	54	14
	24627	24626	<b>4502</b>	PAR36	Screw Terminals	28.0	50W	10000	400	52	29
	24640	24638	<b>4505</b>	PAR36	Screw Terminals	28.0	50W	45000	400	52	30
	24650	24649	<b>4509</b>	PAR36	Screw Terminals	13.0	100W	110000	25	52	20
	41503	41504	<b>4509X</b>	PAR36	Screw Terminals	13.0	100W	110000	25	52	21
	24654	24653	<b>4510</b>	PAR36	Screw Terminals	6.4	25W	800	300	50	26
	24663	24661	<b>4511</b>	PAR36	Screw Terminals	6.2	30W	2300	300	50	22
	24667		<b>4512*</b>	PAR36	Screw Terminals	4.7	0.50A	150	100	50	8
	24673	24671	<b>4515</b>	PAR36	Screw Terminals	6.4	30W	55000	100	50	28
	15133		<b>H4515</b>	PAR36	Screw Terminals	6.4	30W	67000	100	51	1
	24678		<b>4516</b>	PAR36	Screw Terminals	6.2	30W	45000	300	50	21



# Index — Sealed Beam Lamps

Order Code			Lamp No.	Bulb	Base	Design		Initial Max. Beam Candlepower (Approx.)	Rated Average Lab Life (Hours)	Page No.	Line No.
Blister Pack	Unit Pack	Bulk Pack				Volts	Watts or Amps				
	24690	24689	<b>4519</b>	PAR36	Screw Terminals	13.0	100W	30000	25	52	22
	24700		<b>4522</b>	PAR46	Screw Terminals	13.0	250W	290000	25	54	20
	24721		<b>4530</b>	PAR46	Screw Terminals	26.0	5.30A	100000	50	54	23
	24726	24727	<b>4531</b>	PAR46	Screw Terminals	12.5	40W	30000	400	53	14
	19628		<b>4532*</b>	PAR46	Screw Terminals	28.0	250W	75000/14500	100/100	55	1
	24735	24733	<b>4535</b>	PAR46	Screw Terminals	6.4	30W	95000	100	53	11
	24742		<b>4537</b>	PAR46	Screw Terminals	13.0	100W	200000	25	54	17
	40822	40823	<b>4537-2</b>	PAR46	Screw Terminals	13.0	100W	200000	25	54	18
	39022	39023	<b>4537X</b>	PAR46	Screw Terminals	13.0	100W	200000	25	54	19
	24756		<b>4541</b>	PAR56	Screw Terminals	28.0	450W	470000	25	55	23
	24764		<b>4543</b>	PAR56	Screw Terminals	12.5	100W	250000	50	55	12
	24768		<b>4545</b>	PAR56	Screw Terminals	12.0	100W	225000	100	55	11
	24780	24783	<b>4546</b>	PAR36	Screw Terminals	4.7	0.50A	6300	100	50	6
	24770	24775	<b>4546-1</b>	PAR36	Slip-on Terminals	4.7	0.50A	6300	100	50	7
	24788	24787	<b>4547</b>	PAR36	Screw Terminals	4.75	1.25A	20000	100	50	9
	43912		<b>4547-4</b>	PAR36	Screw Terminals	4.75	1.25A	20000	100	50	10
	24795		<b>4551</b>	PAR46	Screw Terminals	28.0	250W	75000	25	54	31
	40576		<b>4552</b>	PAR64	Screw Terminals	28.0	250W	500000	25	55	24
	24799	24801	<b>4553</b>	PAR46	Screw Terminals	28.0	250W	300000	25	54	32
	24802		<b>4554</b>	PAR46	Screw Terminals	28.0	450W	90000	25	55	2
	37706		<b>Q4554</b>	PAR46	Screw Terminals	28.0	450W	65000	100	55	3
	40583		<b>4555</b>	PAR64	Screw Terminals	115.0	1000W	600000	25	55	31
	40581		<b>4557</b>	PAR64	3 Screw Terminals	28.0/28.0	1000W/400W	540000/100000	25/100	55	29
	40578		<b>4559</b>	PAR64	Screw Terminals	28.0	600W	600000	25	55	25
	40579		<b>Q4559</b>	PAR64	Screw Terminals	28.0	600W	600000	100	55	26
	42552		<b>Q4559X</b>	PAR64	Screw Terminals	28.0	600W	765000	100	55	27
	41097		<b>Q4566</b>	PAR46	Screw Terminals	28.0	450W	150000	1000	55	8
	24828	24827	<b>4570</b>	PAR46	Screw Terminals	28.0	150W	32000	300	54	28
	19502		<b>4570X*</b>	PAR46	Screw Terminals	28.0	150W	32000	300	54	27
	24830	24831	<b>4571</b>	PAR46	Screw Terminals	28.0	150W	7000	300	54	29
	24833		<b>4572</b>	PAR46	Screw Terminals	28.0	150W	4500	300	54	30
	25005	25007	<b>4578</b>	PAR46	2 Contact Lugs	28.0	60W	1600	800	54	24
	25009	25011	<b>4579</b>	PAR46	3 Contact Lugs	28.0	80W/60W	24000/11000	400/400	54	26
	24859		<b>4580</b>	PAR46	Screw Terminals	28.0	450W	400000	10	55	4
	24862		<b>4581</b>	PAR46	Screw Terminals	28.0	450W	400000	10	55	5
	24853		<b>4582</b>	PAR46	Screw Terminals	28.0	450W	20000	10	55	6
	24867		<b>4587</b>	PAR36	Screw Terminals	28.0	250W	40000	25	53	5
	24873	24871	<b>4589</b>	PAR36	Screw Terminals	28.0	50W	5000	400	52	31
	24882		<b>4591</b>	PAR36	Screw Terminals	28.0	100W	90000	25	52	36
	24887		<b>4593</b>	PAR36	Screw Terminals	28.0	50W	1500	400	52	32
	24891		<b>4594</b>	PAR36	Screw Terminals	28.0	100W	70000	300	53	1
	24892		<b>4595</b>	PAR36	Screw Terminals	13.0	100W	60000	300	52	23
	24898	24896	<b>4596</b>	PAR36	Screw Terminals	28.0	250W	150000	25	53	6
	37372		<b>Q4597</b>	PAR46	Screw Terminals	28.0	450W	16000	1000	55	7
	24914		<b>4603</b>	PAR36	Screw Terminals	12.8	35W	2800	300	51	27
	10399		<b>4603X</b>	PAR36	Screw Terminals	12.8	35W	2800	300	51	28
	24940		<b>4614</b>	PAR36	Screw Terminals	6.0	100W	85000	300	50	20
	24964		<b>4626</b>	PAR36	Screw Terminals	28.0	150W	25000	300	53	4

# Index — Sealed Beam Lamps

Order Code			Lamp No.	Bulb	Base	Design		Initial Max. Beam Candlepower (Approx.)	Rated Average Lab Life (Hours)	Page No.	Line No.
Blister Pack	Unit Pack	Bulk Pack				Volts	Watts or Amps				
	24966		<b>4627</b>	PAR36	Screw Terminals	28.0	100W	3000	300	53	2
	40577		<b>Q4629</b>	PAR64	Screw Terminals	28.0	600W	20000	1000	55	28
	34537		<b>Q4631</b>	PAR36	Screw Terminals	13.0	250W	80000	500	52	26
	39112		<b>Q4632</b>	PAR36	Screw Terminals	13.0	250W	70000	500	52	27
	33284		<b>4635</b>	PAR46	Screw Terminals	16.5	450W	325000	25	54	22
	19632	16407	<b>4636-3*</b>	PAR46	Combination	14.0	80W	90000	200	54	21
	18517	41861	<b>4651</b>	165 mm	2 Contact Lugs	12.8	50W	SAE	200	49	13
	18532	45027	<b>H4651</b>	165 mm	2 Contact Lugs	12.8	50W	SAE	200	49	14
	18541		<b>HP4651*</b>	165 mm	2 Contact Lugs	12.8	50W	SAE	200	49	15
	18518	41862	<b>4652</b>	165 mm	3 Contact Lugs	12.8/12.8	40W/60W	SAE	200/320	49	17
	18533	49810	<b>H4656</b>	165 mm	3 Contact Lugs	12.8/12.8	35W/35W	SAE	200/320	49	18
	18540		<b>HP4656*</b>	165 mm	3 Contact Lugs	12.8/12.8	35/35W	SAE	200/320	49	19
	18535		<b>H4666</b>	165 mm	3 Contact Lugs	12.8/12.8	45W/65W	SAE	150/320	49	21
	43277		<b>4667</b>	PAR36	Mogul End Prongs	6.4	18W	SAE	200	50	25
	37859		<b>4675</b>	PAR36	Slip-on Terminals	13.0	75W	15000	300	52	19
	36271		<b>Q4681</b>	PAR46	Screw Terminals	28.0	450W	310000	50	55	9
	39906	39907	<b>4700</b>	PAR36	3 Screw Terminals	13.0/13.0	100W/100W	100000/50000	25/25	52	24
	18536		<b>H4701</b>	150 mm	2 Lugs	12.8	65W	SAE	150	49	12
	18538		<b>H4703</b>	150 mm	2 Lugs	12.8	55W	SAE	320	49	11
	44721		<b>4750</b>	PAR36	Screw Terminals	28.0	60W	5000	800	52	34
	44724	44725	<b>4752</b>	PAR36	Screw Terminals	28.0	60W	2000	800	52	35
	24973		<b>4800</b>	PAR56	3 Contact Lugs	28.0/28.0	50W/40W	SAE	400/400	55	20
	24980	24979	<b>4811</b>	PAR36	3 Contact Lugs	28.0/28.0	110W/55W	SAE	400/400	53	3
	24981	24982	<b>4825R</b>	PAR36	3 Screw Terminals	28.0/28.0	50W/18W	200/40	200/200	52	33
	40663		<b>4860</b>	PAR56	Waterproof Terminals	28.0/28.0	80W/60W	SAE	400/400	55	21
	40665		<b>4863</b>	PAR56	Waterproof Terminals	28.0/28.0	80W/80W	SAE	400/400	55	22
	24995	24996	<b>4880</b>	PAR46	2 Contact Lugs	28.0	60W	6000	800	54	25
	45110	45111	<b>4912-1</b>	165 mm	Slip-on Terminals	12.8	50W	14000	300	49	22
	45112	45113	<b>4913-1</b>	165 mm	Slip-on Terminals	12.8	50W	1350	400	49	23
	45114		<b>4919-1</b>	165 mm	Slip-on Terminals	12.8	50W	3750	400	49	24
	45116	16195	<b>4921-1</b>	165 mm	Slip-on Terminals	12.8	100W	—	300	49	26
	18522		<b>H5001</b>	PAR46	2 Contact Lugs	12.8	50W	SAE	200	54	6
	18523	49801	<b>H5006</b>	PAR46	3 Contact Lugs	12.8/12.8	35W/35W	SAE	200/320	53	27
	19428	19559	<b>H5024*</b>	PAR56	3-Contact Lugs	12.8/12.8	65W/42W	SAE	400/2000	55	15
	19411	19556	<b>H5051*</b>	165 mm	2-Contact Lugs	12.8	50W	SAE	500	49	16
	19429	19558	<b>H5054*</b>	200 mm	3-Contact Lugs	12.8/12.8	65W/42W	SAE	400/2000	50	4
	19412	19557	<b>H5062*</b>	165 mm	3-Contact Lugs	12.8/12.8	40W/55W	SAE	400/2000	49	20
	19431	19560	<b>H5501*</b>	PAR46	2-Contact Lugs	12.8	50W	SAE	500	54	7
	19430	19565	<b>H5506*</b>	PAR46	3-Contact Lugs	12.8/12.8	40W/55W	SAE	400/2000	53	28
	16152		<b>5557</b>	PAR64	3 Screw Terminals	28.0/28.0	1000W/400W	540000/100000	50/100	55	30
	20667		<b>5712HI*</b>	PAR46	2 Contact Lugs	12.8	50W	ECE	200	53	32
	20668		<b>5731*</b>	PAR46	3 Contact Lugs	12.8	37.5W/60W	ECE	320/150	53	33
	25114		<b>6006</b>	PAR56	3 Contact Lugs	6.1/6.2	50W/40W	SAE	300/500	55	10
	18519	37837	<b>6014</b>	PAR56	3 Contact Lugs	12.8/12.8	60W/50W	SAE	200/320	55	13
	38416	38607	<b>6015</b>	PAR56	3 Contact Lugs	12.8/12.8	60W/50W	SAE	300/500	55	16
	18525	13030	<b>H6024</b>	PAR56	3 Contact Lugs	12.8/12.8	65W/35W	SAE	150/320	55	14
	25153		<b>6045*</b>	PAR56	Screw Terminals	26.0	170W	230000	100	55	19



# Index — Sealed Beam Lamps

Order Code			Lamp No.	Bulb	Base	Design		Initial Max. Beam Candlepower (Approx.)	Rated Average Lab Life (Hours)	Page No.	Line No.
Blister Pack	Unit Pack	Bulk Pack				Volts	Watts or Amps				
	18521	43867	<b>6052</b>	200 mm	3 Contact Lugs	12.8/12.8	65W/55W	SAE	150/320	50	1
	18298	18002	<b>6053*</b>	PAR56	3-Contact Lugs	12.8/12.8	65W/55W	SAE	150/640	50	5
	18534	11545	<b>H6054</b>	200 mm	3 Contact Lugs	12.8/12.8	65W/35W	SAE	150/320	50	2
	18544		<b>HP6054*</b>	200 mm	3-Contact Lugs	12.8/12.8	65W/35W	SAE	150/320	50	3
			<b>7014*</b>	PAR56	3 Contact Lugs	12.8/12.8	60W/45W	ECE	150/320	55	17
	20669		<b>7021HI*</b>	PAR56	3 Contact Lugs	12.8/12.8	75W/50W	ECE	150/320	55	18
	40190	40191	<b>7400</b>	PAR36	Slip-on Terminals	12.8	35W	33000	300	51	31
	42384	42385	<b>7400-1</b>	PAR36	Screw Terminals	12.8	35W	33000	300	51	32
	43347		<b>7400R</b>	PAR36	Slip-on Terminals	12.8	35W	4900	300	51	33
	39987	39988	<b>7414Y</b>	PAR36	Screw Terminals	12.8	18W	1000	300	51	11
	12818		<b>H7514</b>	PAR36	Screw Terminals	12.8	9W	750	300	51	6
	43561	43562	<b>H7550</b>	PAR36	Screw Terminals	6.0	8W	25000	50	50	15
	43564	43565	<b>H7551</b>	PAR36	Screw Terminals	6.0	8W	550	50	50	16
	43567		<b>H7552</b>	PAR36	Screw Terminals	6.0	10W	650	50	50	17
	43570	43571	<b>H7553</b>	PAR36	Screw Terminals	6.0	12W	850	50	50	18
	43573	43574	<b>H7554</b>	PAR36	Screw Terminals	6.0	20W	1400	50	50	19
	44642	44643	<b>H7555</b>	PAR36	Screw Terminals	12.0	8W	550	50	51	2
	44924	44925	<b>H7556</b>	PAR36	Screw Terminals	6.0	6W	400	50	50	11
	12720	12171	<b>H7557</b>	PAR36	Screw Terminals	12.0	12W	850	50	51	3
	42841	42842	<b>H7600</b>	PAR36	Screw Terminals	12.8	37.5W	60000	300	51	34
	12378		<b>H7601-1</b>	PAR36	Slip-on Terminals	12.8	37.5W	4300	300	51	35
	43576	43577	<b>H7604</b>	PAR36	Screw Terminals	12.8	50W	100000	100	52	9
	14616	43580	<b>H7606</b>	PAR36	Screw Terminals	12.8	50W	1000	400	52	5
	19276	17672	<b>H7607*</b>	PAR36	Screw Terminals	12.8	65W	1500	600	52	18
	14617	43583	<b>H7609</b>	PAR46	Screw Terminals	12.8	50W	2200	400	54	8
	14618	43586	<b>H7610</b>	PAR36	Screw Terminals	12.8	50W	5200	400	52	6
		16480	<b>H7610-1</b>	PAR36	Slip-on Terminals	12.8	50W	5200	400	52	7
	49695	49696	<b>H7612</b>	PAR46	Screw Terminals	12.8	37.5W	15000	450	54	2
	41865	41866	<b>7613</b>	PAR36	Screw Terminals	6.0	8W	400	50	50	13
	45101	45102	<b>7613-1</b>	PAR36	Slip-on Terminals	6.0	8W	400	50	50	14
	49731	49732	<b>H7614</b>	PAR36	Screw Terminals	12.8	50W	2000	100	52	8
	42838	42839	<b>H7616</b>	PAR36	Screw Terminals	12.8	37.5W	70000	300	52	1
	14619	43589	<b>H7619</b>	PAR46	Screw Terminals	12.8	50W	6000	400	54	9
	45057	45058	<b>H7621-1</b>	PAR46	Slip-on Terminals	12.8	50W	20000	200	54	10
	43591	43592	<b>H7635</b>	PAR46	Screw Terminals	12.8	50W	160000	100	54	11
	18019	18022	<b>H7635X</b>	PAR46	Screw Terminals	12.8	50W	160000	100	54	12
	11421	11422	<b>7672-1</b>	PAR36	Slip-on Terminals	6.0	7.2W	350	50	50	12
	45060		<b>H7675-1</b>	PAR36	Slip-on Terminals	12.8	50W	15000	200	52	10
	13425	13426	<b>H7921-1</b>	165 mm	Slip-on Terminals	12.8	50W	23900	200	49	27
	14890	14892	<b>H7935-1</b>	165 mm	Slip-on Terminals	12.8	50W	175000	100	49	25
	15767	15763	<b>H9405</b>	150 mm	2 Lugs, Rt. Angle	12.8	50W	100000	100	49	5
	15769	15768	<b>H9406</b>	150 mm	2 Lugs, Rt. Angle	12.8	50W	5400	400	49	6
	15771	15770	<b>H9411</b>	150 mm	2 Lugs, Rt. Angle	12.8	50W	5400	400	49	7
	15773	15772	<b>H9414</b>	150 mm	2 Lugs, Rt. Angle	12.8	50W	2700	400	49	8
	16484	16483	<b>H9415</b>	150 mm	2 Lugs, Rt. Angle	12.8	37.5W	12000	200	49	3
	17988	17989	<b>H9415A*</b>	150 mm	2 Lugs, Rt. Angle	12.8	37.5W	—	200	49	4
	16976	16978	<b>H9420</b>	150 mm	2 Lugs, Rt. Angle	12.8	50W	SAE	200	49	9
	16482	16204	<b>H9421</b>	150 mm	2 Lugs, Rt. Angle	12.8	50W	—	200	49	10

## All-Glass Wedge Base Lamp Information

### Introduction

Manufacturers are able to save time, money, weight, and space by using all-glass wedge base lamps instead of conventional metal-base miniature lamps. With the introduction of all-glass wedge base lamps, GE eliminated a variety of design and cost constraints which had limited the manufacturers of automotive, electrical, and electronic equipment. Potential applications for these low voltage lamps include a wide variety of product lines such as automobiles, trucks, large and small appliances, toys, novelties, aircraft, coin-operated machines, recreational vehicles, fiber-optic devices, building emergency lamps, exit signs, and garden / landscape lamps.

### Why should you choose GE all-glass wedge base lamps?

#### They're small and save on costs

GE all-glass wedge base lamps require only a minimum of space.

And because there's no need for the complicated metal sockets and wiring devices normally used with metal-base lamps, you can save even more space by using printed circuits with simple plastic sockets or clips or molded plastic components.

#### They're easy to use

GE now offers either the lamp alone or the lamp permanently connected to a plastic socket which is designed for printed circuit board applications.

#### Saves time and money

**Lamp** — Just push to install, pull to remove. There's no twisting required, which saves time and money in assembly operations. And the simple push-in motion adapts readily to automatic assembly equipment, even vibratory bowl feeders.

**Lamp/socket integrated** — Just insert into printed circuit board and twist. Saves time and money in assembly operations as lamp is already installed into socket. Super reliable since wedge base lamp is permanently connected to the socket.

In addition, the filament plane is the same from lamp to lamp. So the light from a new all-glass wedge base lamp is always in the same direction as that from the lamp being replaced.

#### They're reliable

GE all-glass wedge base lamps have performed reliably under some of

the most severe operating conditions, including shocks, vibration, heat, cold, and moisture. With no metal base or soldered connections to work loose, break, or corrode, most of these lamps can be operated in ambient temperatures of up to 230°C (450°F) instead of the 175°C (350°F) limit of conventional metal-base lamps.\*

GE increases the corrosion resistance of all-glass wedge base lamps by nickel-plating the lead wires. However, nickel-plated wires are not easily solderable. For extended-lead lamps and subminiature lamps under 12 volts, the leads are cleaned and solderable for a period of six months.

#### And they're available in a full range of types and sizes

GE all-glass wedge base lamps are available in voltages ranging from 2.5 to 28, and in candlepower from .03 to 21. Bulb sizes range from 6 m subminiature to 10 and 16 mm miniature diameters. Sockets for GE all-glass wedge base lamps are commercially available from a number of manufacturers.

Additional information about all-glass wedge base lamps and other GE lighting products may be obtained from your local GE Lamp Representative.

\*Note: The light output of lamps 70, 74, 168, and 194 will be reduced if operated continuously at 230°C.

## High Output Halogen-Cycle Lamp Information

Halogen-cycle lamps, which belong to the incandescent lamp family, are totally unlike conventional miniature lamps. Special high-temperature glass or quartz bulbs enable halogen-cycle lamps to be operated at high wattages and to produce a very high light output from a very small lamp package. The high operational efficiency of halogen-cycle lamps is ensured through strict production quality standards which include: (a) consistency in positioning filaments in each bulb; and (b) uniformity in maintaining the shape and thickness of high-temperature glass bulb tops. Potential applications for these lamps include lanterns, medi-

photocells, photographic equipment, automotive, aircraft, spot/flood lighting, and fiber-optic devices (using lamps with lenses or reflectors).

### What advantages do halogen-cycle lamps have over conventional miniature lamps? Higher light output from less energy and a smaller lamp package.

A simple frame of reference can serve to explain just how much brighter a halogen-cycle lamp is, compared with other ordinary lamps. A typical halogen-cycle miniature lamp rated at 45 watts produces the same light output as a standard

halogen-cycle lamp is 1/3 the size of the household lamp. It's easy to see then, that a small, low-voltage halogen-cycle lamp could produce as much or more light than a large conventional miniature lamp while saving both energy and space.

### And higher maintained light output over life.

Unlike conventional lamps, halogen-cycle lamps can be operated at high wattages without sacrificing the light output over life. So most halogen-cycle lamps produce 85 to 95% of their initial light output at 70% of their life expectancy. The high temperatures these lamp wattages generate allow a lamp's



rated from the filament. The vapor then redeposits these particles back onto the filament, virtually eliminating bulb blackening due to tungsten deposits on the bulb wall.

### GE halogen-cycle lamps are available in a full range of types and sizes.

GE offers halogen-cycle lamps ranging in voltages from 2.5 to 32, and in candlepower from 1.6 to 600. Lamp sizes range from 4.7 mm subminiature to 15 mm miniature diameters. Sockets for GE halogen-cycle lamps are commercially

available from a number of manufacturers.\*\*

Additional information about halogen-cycle lamps and other

GE lighting products may be obtained from your local GE Lamp Representative.

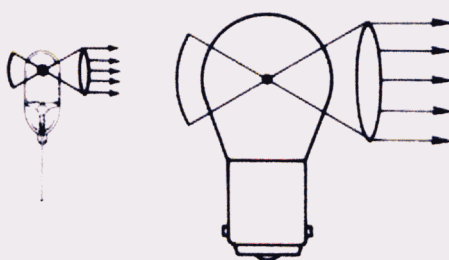

Halogen-cycle lamp versus conventional incandescent lamp of equivalent wattage. Note the much smaller size of the halogen-cycle lamp on the left.

Halogen-cycle lamp versus vacuum incandescent lamp at 70% of life. Note the bulb blackening of the incandescent lamp on the right.

\*\*For Halogen Lamp Types see "Red Lamp Number" in Miniature & Sealed Beam Lamp Specifications.

## Design Features — Halogen Lamps & Sealed Beams

Design factors — such as the lamp socket, limitations, of housing space, power source, light output, wattage, life, ambient temperature, and the possibility of shock and vibration — should be considered carefully when selecting lamps.

### GE manufactures four types of halogen-cycle lamps:

#### Glass halogen miniature lamps.

The increased range in candlepower and wattages of these halogen-cycle lamps allows for many new and present design applications. The lamp design consists of a hemispherical bulb top with more uniform light output than a top-tipped halogen lamp. The sturdy nickel-plated iron leads in two-pin types allow for positive electrical connection, minimizing voltage drops due to intermittent connections. Although these lamps can be damaged by thermal shock, they are not subject to devitrification. Electrical connections to lamps offered with molybdenum leads can be made by crimping or welding.

#### Quartzline® fused-quartz miniature lamps.

Quartzline lamps are normally used in special applications, but can also be used in many general applications if the designer chooses. Although considerably more costly than high-temperature glass halogen-cycle lamps, Quartzline lamps can withstand thermal shock,

A lighted Quartzline lamp, for instance, will not crack or break even when suddenly exposed to water or ice.

#### Glass halogen and Quartzline® fused-quartz sealed beam lamps.

Designated in this catalog by the prefix "H" and "Q", these lamps are being used in many new applications to take advantage of their higher light output compared with standard incandescent sealed beam lamps. Standard PAR 36, PAR 46, PAR 56, and rectangle 150 mm, 165 mm, and 200 mm sizes allow possible use in existing housings,

and several different beam patterns are available for a variety of applications.

### Consider these factors when selecting GE halogen-cycle lamp Lamp Efficacy and Operating Precautions.

The lamps listed in this catalog are filled to high internal gas pressures to maximize lamp efficacy (candlepower or lumens per watt). Because both lamp bulb material and pressure vary by lamp design, different **CAUTION** notices apply. Be sure to see the appropriate notice(s) for the lamp(s) you select.

#### CAUTION

The filament tubes (or bulbs) used in all halogen-cycle lamps generate intense heat, are pressurized and could shatter if scratched or damaged. Glass halogen-cycle bulbs should be protected against liquids when operating.

Use only in fixtures designed for the high temperature required for proper operation and that offer protection in case the bulb shatters. Do not operate in proximity of substances or materials that are flammable or adversely affected by heat or drying. Provide protective screen or shield with equipment in which an unenclosed halogen-cycle bulb is installed or used.

For satisfactory performance: (1) Do not operate above rated voltage; (2) for wire terminal lamps, if further processing of the leads, such as bending, welding, crimping, etc. is required, care must be taken to assure that the lamp seal area is not strained, cracked, chipped, or other-

ure may occur; (3) limit seal and outer lead wire temperature to 350 degrees C or lead wire deterioration may occur; (4) maintain a minimum bulb wall temperature of 250 degrees C for operation of the halogen cycle; (5) remove grease or fingerprints from quartz halogen-cycle bulbs with a grease-free solvent before use.

Use appropriate protection to avoid risk of injury when handling or disposing of all halogen-cycle bulbs. Wear eye protection. Turn power off when installing or before removing lamp. Allow lamp to cool before removal.

Sealed beam halogen lamps use an inner halogen-cycle bulb. If the outer sealed envelope is broken, replace the lamp. Do not use even though it appears to be operable; carefully remove and dispose of the lamp by placing it in a closed container.

A complete statement of precautions is

## High Operating Temperatures

Because operating temperatures (watts plus environment) are critical to the effectiveness of the self-cleaning properties of halogen-cycle lamps, bulb wall temperatures should not go below 250°C. Hot spots on the bulb wall itself can go as high as 700°C in normal operation.

Substantial heat is generated in all halogen-cycle lamps, so allowances should be made for the dissipation of excessive heat in equipment design. Certain lamps and extremely confined fixtures may require addi-

tional ventilation or heat sinking to ensure proper operation of the halogen cycle and prevent damage to the fixture. It is a good practice to test the lamp in the operating environment early in the design cycle to ensure adequate performance. **Precautions must be taken in the selection of materials for lampholders, reflectors, and lamp housings because the 700°C bulb wall temperature is greater than the kindling temperatures of many materials.**

Lamp base temperatures should not exceed 350°C because, above that point, lead wires may deteriorate and the basing cement may loosen, causing premature lamp failure.

## Distribution of Spectral Radiation

Halogen-cycle lamps offer great amounts of visible and infrared energy from a small light source, with about 90% of the energy in the infrared. Some GE lamps can be used for special applications where small amounts of ultraviolet energy are required.

## Design Features — Miniature Lamps

Design factors — such as the lamp socket, limitations of housing space, power source, light output, wattage, life, ambient temperature, and the possibility of shocks and vibration — should be considered carefully when selecting lamps.

### Light Quantity and Quality

Where an object or surface is to be illuminated, the quantity of light required depends upon the size of the object, the brightness desired, the contrast with its background, and the time available for seeing.

Where light must be projected, either a separate reflector and lamp or a reflectorized lamp may be required. Consideration should be given to beam candlepower and beam speed.

The spectral quality of color of light can be modified by external filters or coatings applied to the bulb.

to published life. The data, particularly for lamp life, do not apply accurately for lamp operation on

half-wave rectified voltage, semiconductor dimming devices, and constant-current operation.

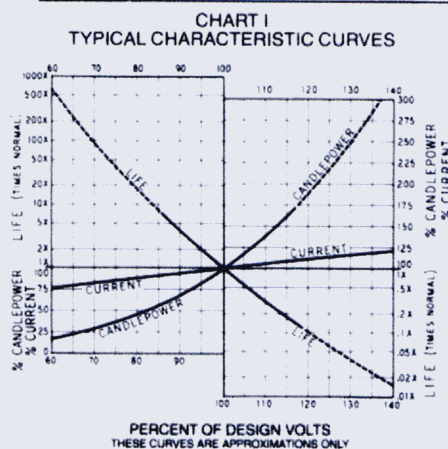

TABLE I

UNDERRATED BULB VOLTAGES (100%<)				OVERRATED BULB VOLTAGES (100%>)			
VOLTS %	AMPS %	MSCP %	LIFE %	VOLTS %	AMPS %	MSCP %	LIFE %
99	99.4	96.5	112.8	101	100.5	103.5	88.7
98	98.9	93.2	127.4	102	101.1	107.2	78.8
97	98.3	89.9	144.1	103	101.6	110.9	70.1
96	97.8	86.7	163.2	104	102.2	114.7	62.5
95	97.2	83.6	185.1	105	102.7	118.6	55.7
90	94.4	69.2	354.1	110	105.4	139.6	31.9
85	91.4	56.6	703.0	115	108.0	163.1	18.7
80	88.5	45.8	1455.2	120	110.5	189.3	11.2
75	85.4	36.5	3156.9	125	113.1	218.4	6.9
70	82.2	28.7	7224.8	130	115.5	250.5	4.3

NOTE: Calculations of characteristics shown in Chart I and Table I are approximate only between 95% and 110% of rated voltage for lamp types with 5,000 hours life or less. Certain lamp types will vary widely from calculated values. This chart will not apply to lamps with lives in excess of 5,000 hours or to halogen-cycle lamps. Consult your local GE Lamp Representative for application information.

### Light, Life, and Voltage

For any particular lamp, the light output and life depend upon the voltage at which a lamp is operated. For instance, as approximations, the light output varies as the 3.6 power of the voltage and the life varies inversely as the 12th power of the voltage. Chart I and Table I illustrates the effect of overvoltage or undervoltage applied to a lamp on its current, life, and light (candlepower) output. Indicated values (except for long-life lamps) are reasonably valid, between 95% and 110% rated volts. Beyond that, indicated characteristics may not be realized because of the increasing influence of factors which cannot be incorporated into the chart.

The chart applies only to D.C. or

### Mechanical Strength

Low-voltage, high-current incandescent lamps are best suited for operation under conditions of shocks and vibration. Other factors affecting strength are the resonant frequency of lead wires and filament form. Most radio panel lamps of 6.3 volts and under incorporate mounts whose resonant frequency has been synchronized with that of the coiled filament to withstand shocks and vibration. Where rough service conditions are encountered, screw base lamps should be avoided since they may loosen in their sockets. Higher voltage lamps of similar light output and life have longer, thinner filaments which are more prone to shock and vibration failures.

### Power Sources

ally higher than the average volts. The mean effective voltage, therefore, should be the design voltage of the lamp. Design voltages for flashlight lamps have been determined by extensive tests.

Filament lamp ratings are predicated on operation at a constant voltage. When operated from a higher-than-rated voltage in series with a dropping resistor, the effect is the same as operating at a constant current. Since the lamp resistance changes with operating life, the voltage drop across the lamp will increase; hence, the lamp life experienced will generally be about one half that resulting from constant-voltage operation.

When selecting a transformer or resistor, consideration should be



Since integrated circuit applications are operated on D.C. and, in general, constant current, lamps used with them offer less life than applications where A.C. voltage and higher current can be tolerated. This is because the D.C. notching phenomenon occurs in greater percentage on low-current lamps, and the life is approximately 50% under constant current than that under controlled voltage. This half-life on constant current occurs because the filament is evaporating and becoming smaller as the lamp is operating, gradually increasing in resistance and requiring a rise in voltage to maintain a constant current value. This, in turn, increases the wattage and the filament temperature, causing an increase in the efficiency of the lamp.

### Space

Tolerances of bulb diameters, light center lengths, and overall lengths should be carefully considered by designers when specifying lamp housings. These tolerances and more-detailed drawings are available from your local GE Lamp Representative.

### Ambient Temperature

It is important to consider the lamp housing from the standpoints of radiation, absorption, and ventilation. Normal variations in ambient temperature do not affect the performance of miniature lamps. Above 175°C (350°F), the solder on conventional lamps may soften, deform, or melt, and the basing cement may loosen. All-glass wedge base lamps can be operated in lamp ambient temperatures of up to 230°C (450°F).

### Inrush Current

The initial current through a filament is called the inrush current. Cold resistance of a filament is generally considered to be that of room temperature, while the hot resistance depends upon the temperature of the filament (which varies with lamp size). Inrush current can be approximately 12 times as great as the normal operating current. This maximum value is seldom reached because the impedance in the circuit reduces it. However, equipment designers should take both inrush current and resistance into consideration when selecting a lamp. Chart II displays the general range of inrush current versus time after voltage is applied to a cold

by applying a low value of pre-heat voltage.

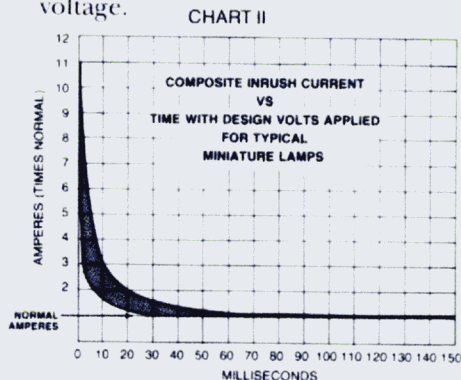

Tungsten filaments are more fragile at temperatures below the 250°C brittle-ductile region. This fragility can be reduced by using a keep-alive voltage or current in the off condition. A general recommendation for keep-alive requirements is 25% of the design voltage or current. This will reduce the inrush current from approximately 12 times to 4 times, depending upon the lamp type.

### Incandescence and Nigrescence

The rate of rise and decay time depends upon the mass of the filament to be heated. In general, the incandescence (rise time) to 90% brightness is about 100 to 300 milliseconds, and the nigrescence (decay time) is about 40 to 100 milliseconds. These values vary with each lamp type. The times are directly related to the lamp current; therefore, low-current lamps have the fastest response times.

### Cleaned and Solderable Leads

Most General Electric wire terminal lamps are cleaned at the factory and furnished in an easily solderable state. This treatment makes the lamps easily solderable for a period of at least 6 months after receipt of product.

Lead wires used in the manufacture of most lamps have a borate coating to ensure a good metal-to-glass seal (where the lead wires enter the bulb). This coating interferes with soldering and must be removed where soldering is necessary. In applications where wire terminal lamps are connected by crimping or pressure contact, the cleaned and easily solderable leads eliminate the possibility of a poor connection. For more information, contact your local GE Lamp Representative.

### Flashing and Pulsing

Incandescent lamps have been used successfully in flashing and pulsing

lamp life in some cases. For more information, contact your local GE Lamp Representative.

### Redundant System Philosophy

Two-filament lamps with filaments connected in parallel for additional reliability are not new. Experience has shown, however, that in many cases, the second filament has failed by the time it is needed. Thus, these lamps have never become very popular.

A more reliable system would be to use two or more lamps operating at the same time. Since they are physically separated from each other, it is easy to see when one has failed. This lamp can be replaced immediately, prior to the failure of the second lamp.

### Color Temperature

The radiation from tungsten filaments used in General Electric lamps is similar to that from a "black body" at specific temperatures. This can be determined approximately from Chart III. Use the published lamp ratings (or estimated derated values) in this catalog. The catalog indicates whether a lamp is vacuum or gas-filled.

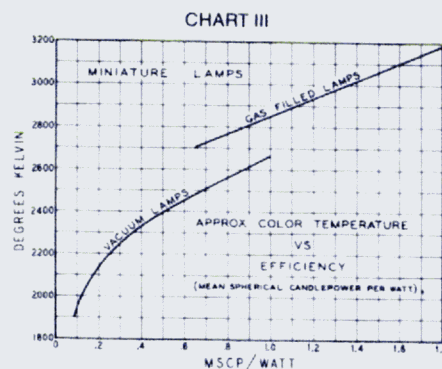

### Lamp Life

Rated average life is that obtained in closely controlled laboratory testing of lamps on 60 Hertz Alternating Current at their design voltage. Certain lamps are tested with Direct Current and are footnoted accordingly. Very long life lamps are generally rated on the basis of extrapolated laboratory test data. Service conditions such as shocks, vibration, voltage fluctuations, temperature, etc., may contribute to a shorter average service life.

Ordinarily, for still-rack operation, normal tungsten filament evaporation is the basic force or mechanism controlling incandescent lamp life. Where normal filament evaporation is the dominant failure mechanism, lamps should reach their design-

In recent years, another filament mechanism has been identified which may reduce life to one-half or much less of its design-predicted value. It is commonly referred to as "filament notching." Notching is the appearance of step-like or saw-tooth irregularities, appearing on all or part of the tungsten filament surface, after some burning.

These notches reduce the filament wire diameter at various points. In some cases, especially in fine-wire diameter lamps, the notching is so severe as to almost penetrate the entire wire diameter. Thus accelerated spot evaporation due to this notching (as well as reduced filament strength) now becomes the dominant mechanism for influencing lamp life. Because of its abnormal evaporation and/or reduced strength effects, lamp lifetimes due to notching are substantially lessened.

Notching has been due to at least three factors:

1. Low-temperature filament operation, less than that for significant normal tungsten evaporation. (Long-life lamp designs, such as 10,000-, 25,000-, 50,000-, and 100,000-hour designs. This does not apply to filament temperatures below 1600°C.)
2. Small filament-wire sizes, less than one mil (.001") diameter in many cases, typical of low-amperage lamps.
3. Increased use of D.C. voltage operation (generally resulting from advances in solid state technology).

Subminiature lamps, those with bulb sizes of T-2 and below, have been the most susceptible candidates for filament notching. By their very nature they have small

diameter filaments, are often soldered into place in their applications to save space, and are operated at low filament temperatures in an effort to prolong life. Lamps listed in this catalog with "Rated Average Lab Life" footnote 38, 42, 43, 79, and 116 may be susceptible to notching. Since notching is very difficult to predict, it is recommended that lamps susceptible to this phenomenon be easily replaceable in their applications.

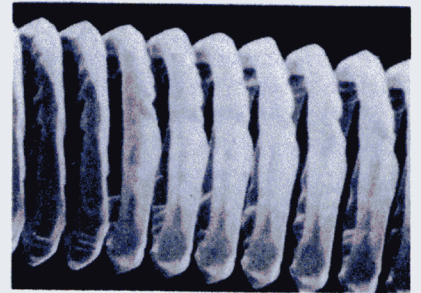

An example of filament notching.

## Miniature Filaments and Bases

### Filaments

Filaments for miniature and sub-miniature lamps may be a straight wire, a coil, or a coiled coil (indicated by the letters "S", "C", and "CC" respectively). Coiling the filament wire effectively shortens the filament length so that smaller bulbs can be used. In addition, in gas-filled lamps, coiling the wire reduces thermal losses and increases efficiency. Tungsten is almost universally used as lamp filament material because of its high melting point at incandescence. The number following the coil identification letter(s) denotes the arrangement of the filament on the supports.

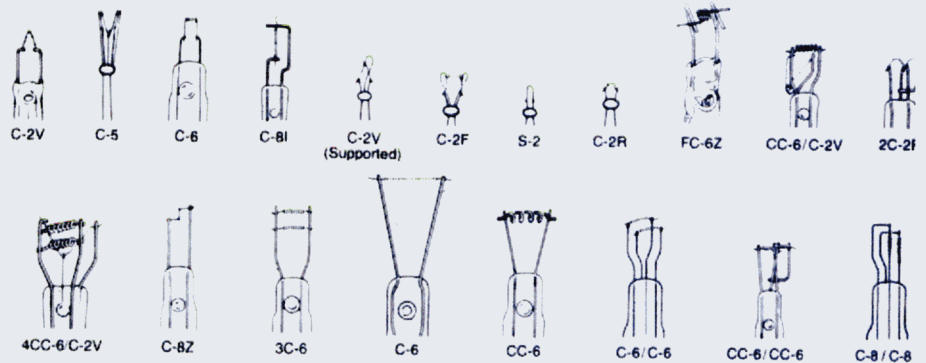

### Bases

Bases provide electrical contact to the lamp and, in most cases, also support the lamp in the fixture. For miniature and subminiature lamps, bayonet or wedge base types are generally preferred over screw types when vibration is present. In addition, wedge bases reduce socket size and complexity. (For complete information about the benefits of all-glass wedge base lamps, refer to page 10 of this catalog.) Flanged or collared types are usually associated with requirements for filament location.

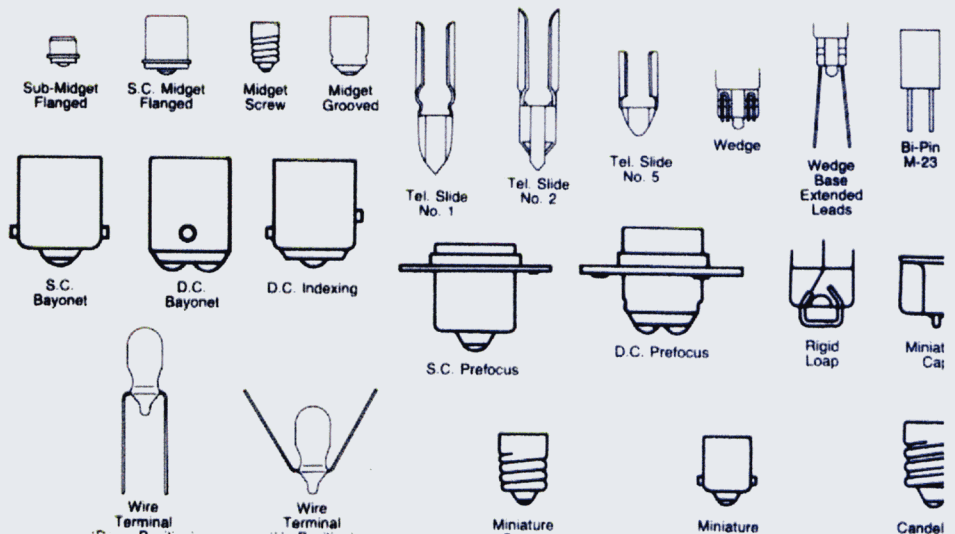



# Miniature Lamp Specifications

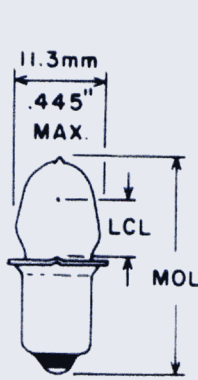

Fig. 1  
B-3/4

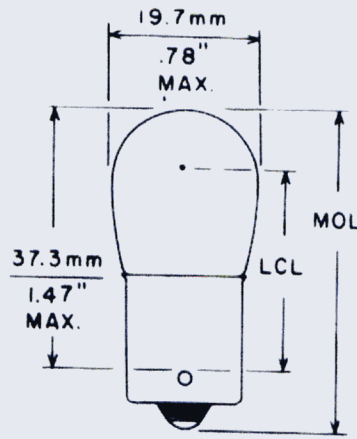

Fig. 2  
B-6

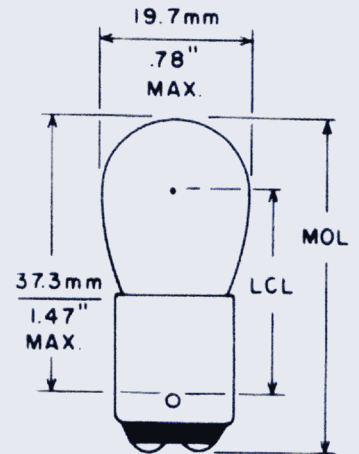

Fig. 3  
B-6

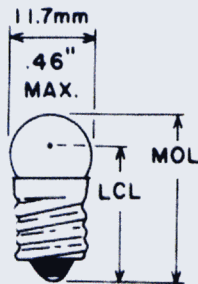

Fig. 4  
G-3/4

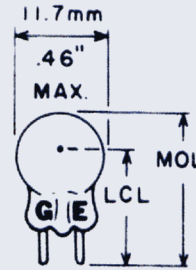

Fig. 5  
G-3/4

Line No.	GE Lamp No.	Primary Application	Design Volts	Design Watts or Amps	Mean Spherical Candle-Power (Approx.)	Base	Atmosphere B-Vac./C-Gas	Filament Designation	Light Center Length (Inches)	Max. Overall Length (Inches)	Rated Average Lab Life (Hours)	Fig. No.
----------	-------------	---------------------	--------------	----------------------	---------------------------------------	------	-------------------------	----------------------	------------------------------	------------------------------	--------------------------------	----------

## B-3/4 BULB 7/16" (11mm) DIAMETER

1	KPR141	Flashlight, Krypton, Rechargeable <sup>(159)</sup>	2.0	1.20A	1.40	S.C. Miniature Flanged	C	C-2R	.25	1.25	15 <sup>(116)</sup>	1
2	PR4	Flashlight — 2C Cells	2.33	.27A	.40	S.C. Miniature Flanged	B	C-2R	.25	1.25	10 <sup>(116)</sup>	1
3	PR2	Flashlight — 2D Cells	2.38	.50A	.80	S.C. Miniature Flanged	B	C-2R	.25	1.25	15 <sup>(116)</sup>	1
4	PR37	Flashlight, Rechargeable	2.45	1.20A	2.00	S.C. Miniature Flanged	C	C-2R	.25	1.25	40 <sup>(116)</sup>	1
5	PR6	Flashlight — 2D Industrial Cells	2.47	.30A	.45	S.C. Miniature Flanged	B	C-2R	.25	1.25	30 <sup>(116)</sup>	1
6	PR9	Flashlight — 2D Cells	2.7	.15A	.25	S.C. Miniature Flanged	B	C-2R	.25	1.25	45 <sup>(116)</sup>	1
7	395X	Flashlight — 2D Cells Special Service	3.0	.70A	.15	S.C. Miniature Flanged	B	S-2	.25	1.25	50 <sup>(116)</sup>	1
8	PR3	Flashlight — 3D Cells	3.57	.50A	1.50	S.C. Miniature Flanged	B	C-2R	.25	1.25	15 <sup>(116)</sup>	1
9	PR7	Flashlight — 3D Industrial Cells	3.7	.30A	.90	S.C. Miniature Flanged	B	C-2R	.25	1.25	30 <sup>(116)</sup>	1
10	PR30	Flashlight — Rechargeable	3.75	.86A	2.25	S.C. Miniature Flanged	C	C-2R	.25	1.25	40 <sup>(116)</sup>	1
11	KPR139	Flashlight, Krypton, Rechargeable <sup>(159)</sup>	3.85	1.20A	5.10	S.C. Miniature Flanged	C	C-2R	.25	1.25	15 <sup>(116)</sup>	1
12	KPR140	Flashlight, Krypton, Rechargeable <sup>(159)</sup>	4.0	.90A	4.00	S.C. Miniature Flanged	C	C-2R	.25	1.25	15 <sup>(116)</sup>	1
13	PR13	Hand Lantern — 4F Cells	4.75	.50A	2.20	S.C. Miniature Flanged	C	C-2R	.25	1.25	15 <sup>(116)</sup>	1
14	PR15	Hand Lantern — 8F Cells	4.82	.50A	1.90	S.C. Miniature Flanged	C	C-2R	.25	1.25	30 <sup>(116)</sup>	1
15	PR12	Flashlight — 5D Cells	5.95	.50A	3.10	S.C. Miniature Flanged	C	C-2R	.25	1.25	15 <sup>(116)</sup>	1
16	PR18	Flashlight — 6D Cells <sup>(14)</sup>	7.2	.55A	5.50	S.C. Miniature Flanged	C	C-2R	.25	1.25	3 <sup>(116)</sup>	1
17	PR20	Flashlight — 7D Cells <sup>(14)</sup>	8.63	.50A	5.00	S.C. Miniature Flanged	C	C-2R	.25	1.25	15 <sup>(116)</sup>	1

## B-6 BULB 3/4" (19mm) DIAMETER

18	1317	Aircraft Emergency Lighting	6.0	.51A	3.40	S.C. Bayonet	C	C-6	1.12	1.75	100 <sup>(116)</sup>	2
19	210	Instrument	6.5	1.78A	15.00	D.C. Bayonet	C	C-6	1.06	1.75	100	2
20	1003	Auto Interior	12.8	.94A	15.00	S.C. Bayonet	C	C-6	1.06	1.75	200	2
21	1004	Auto Interior and Marine	12.8	.94A	15.00	D.C. Bayonet	C	C-6	1.06	1.75	200	3
22	105	Auto Interior — Heavy Duty	12.8	1.00A	12.00	S.C. Bayonet	C	C-6	1.06	1.75	500	2
23	1309	Aircraft Interior	28.0	.52A	15.00	S.C. Bayonet	C	2C-2R	1.06	1.75	300	2
24	1308	Aircraft Reading Light Spiral Leads	28.0	.56A	16.00	S.C. Bayonet	C	CC-8	1.06	1.75	2,000	2

## G-3/4 BULB 7/16" (11mm) DIAMETER

25	131	Bicycle - 1D Cell	1.3	.10A	.03	Miniature Screw	B	S-2	.72	.94	50 <sup>(116)</sup>	4
26	245	Flashlight - 2D Cells	2.46	.50A	.90	Miniature Screw	B	C-2R	.72	.94	15 <sup>(116)</sup>	4
27	14	Flashlight - 2D Cells	2.47	.30A	.50	Miniature Screw	B	C-2R	.72	.94	15 <sup>(116)</sup>	4
28	10	Indicator <sup>(69)</sup>	2.5	.50A	.50	Miniature Two Pin	B	C-6	.62	.94	3,000	5
29	352X	Special Service	3.0	.07A	.15	Miniature Screw	B	S-2	—	.94	50 <sup>(116)</sup>	4
30	13	Flashlight - 3D Cells	3.7	.30A	.98	Miniature Screw	B	C-2B	.72	.94	15 <sup>(116)</sup>	4
31	12	Radio <sup>(69)</sup>	6.3	.15A	.35	Miniature Two Pin	B	C-6	.62	.94	5,000+ <sup>(144)</sup>	5
32	612	Special Service <sup>(69)</sup>	6.3	.25A	.65	Miniature Two-Pin	B	C-6	.66	.94	5,000+	5

<sup>(13)</sup> Supported.

<sup>(14)</sup> This lamp is specially designed for a particular purchaser and may not be suitable for other uses because of its excessive wattage requirements for the bulb size. Consult the nearest GE Lamp Sales Office for application information.

<sup>(69)</sup> Not recommended for new OEM applications—suggested for new design are wedge base lamps such as GE Lamp Numbers 159, 259, and 161.

<sup>(116)</sup> Life tests are performed on DC voltage only.

# Miniature Lamp Specifications

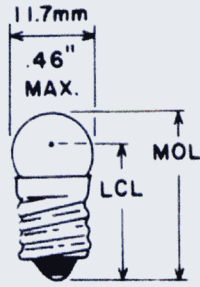

Fig. 4  
G-3 1/2

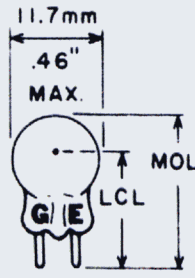

Fig. 5  
G-3 1/2

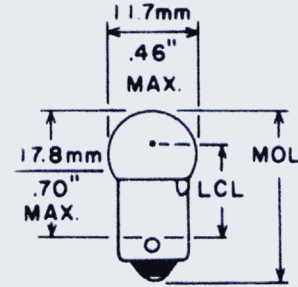

Fig. 6  
G-3 1/2

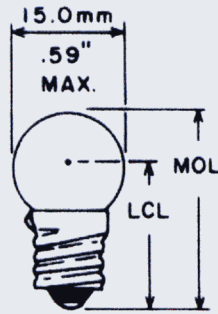

Fig. 8  
G-4 1/2

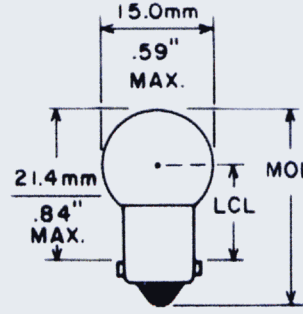

Fig. 9  
G-4 1/2

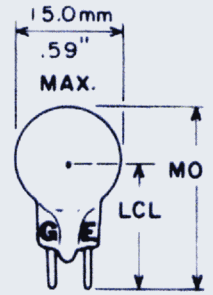

Fig. 10  
G-4 1/2

Line No.	GE Lamp No.	Primary Application	Design Volts	Design Watts or Amps	Mean Spherical Candle-Power (Approx.)	Base	Atmosphere B-Vac./C-Gas	Filament Designation	Light Center Length (Inches)	Max. Overall Length (Inches)	Rated Average Lab Life (Hours)	Fig No.
----------	-------------	---------------------	--------------	----------------------	---------------------------------------	------	-------------------------	----------------------	------------------------------	------------------------------	--------------------------------	---------

## G-3 1/2 BULB 7/16" (11mm) DIAMETER (continued)

1	51	Indicator	7.5	22A	1.0	Miniature Bayonet	B	C-2R	.50	.94	1,000	6
2	1449	Toy Train	14.0	20A	2.0	Miniature Screw	B	C-2V <sup>(13)</sup>	.72	.94	250	4
3	19	Toy Train <sup>(69)</sup>	14.4	10A	9	Miniature Two Pin	B	C-6	.62	.94	1,000	5
4	53	Auto and Indicator	14.4	12A	1.0	Miniature Bayonet	B	C2V <sup>(13)</sup>	.50	.94	1,000	6
5	53X	Auto — Heavy Duty	14.4	12A	.75	Miniature Bayonet	B	C-2F	.50	.94	1,000	6
6	1445	Auto	14.4	135A	7	Miniature Bayonet	B	C-2V <sup>(13)</sup>	.50	.94	2,000	6
		Toy Train Ratings	18.0	15A	1.5	Miniature Bayonet	B	C-2V <sup>(13)</sup>	.50	.94	250	6
7	1447	Toy Train	18.0	15A	1.5	Miniature Screw	B	C-2V <sup>(13)</sup>	.72	.94	250	4
8	1450	Indicator	24.0	035A	23	Miniature Bayonet	B	C-2F	.50	.94	3,000	6
9	265	Indicator	28.0	08A	.75	Miniature Bayonet	B	C-2F	.50	.94	5,000	6
10	356	Aircraft <sup>(14)</sup>	28.0	17A	3.5	Miniature Bayonet	B	C-2F	.50	.94	500	6

## G-4 1/2 BULB 9/16" (14mm) DIAMETER

11	407	Hand Lantern, Flasher Lamp — 4 F Cells <sup>(70)</sup>	4.9	30A	1.2	Miniature Screw	B	C-2R	.81	1.07	50 <sup>(3)(116)</sup>	8
12	27	Hand Lantern — 4 F Cells	4.9	30A	1.4	Miniature Screw	B	C-2R	.72	1.07	30 <sup>(116)</sup>	8
13	425	Hand Lantern — 4 F Cells	5.0	50A	2.3	Miniature Screw	C	C-2R	.72	1.07	15 <sup>(116)</sup>	8
14	502	Hand Lantern — 4 F Cells	5.1	.15A	.6	Miniature Screw	B	C-2R	.72	1.07	100 <sup>(116)</sup>	8
15	503	Hand Lantern — 4 F Cells	5.1	.15A	.6	Miniature Bayonet	B	C-2R	.50	1.07	100 <sup>(116)</sup>	9
16	605	Flashlight — 5 D Cells	6.15	50A	3.4	Miniature Screw	C	C-2R	.72	1.07	15 <sup>(116)</sup>	8
17	455	Indicator, Flasher Lamp <sup>(70)</sup>	6.5	50A	1.9	Miniature Bayonet	C	C-2R	.56	1.07	500 <sup>(3)</sup>	9
18	15	Indicator <sup>(69)</sup>	7.0	40A	2.0	Miniature Two Pin	C	C-6	.69	1.07	500	10
19	55	Instrument	7.0	41A	2.0	Miniature Bayonet	C	C-2R	.56	1.07	500	9
20	57	Auto and Instrument	14.0	24A	2.0	Miniature Bayonet	B	C-2V <sup>(13)</sup>	.56	1.07	500	9
21	57X	Auto and Instrument	14.0	24A	2.0	Miniature Bayonet	B	C-2F	.56	1.07	500	9
22	258	Toy Train, Flasher	14.0	27A	1.6	Miniature Screw	C	C-2R	.81	1.07	500 <sup>(3)</sup>	8
23	257	Auto and Toy Train, Flasher Lamp <sup>(70)</sup>	14.0	27A	1.6	Miniature Bayonet	C	C-2R	.56 <sup>(147)</sup>	1.07	500 <sup>(3)</sup>	9
24	1895	Auto, Truck Marker	14.0	27A	2.0	Miniature Bayonet	B	C-2F	.56	1.07	2,000	9
25	1895R	Indicator — Outside Coated Red <sup>(120)</sup>	14.0	27A	—	Miniature Bayonet	B	C-2F	—	1.07	2,000	9
26	293	Auto and Radio	14.0	33A	2.0	Miniature Bayonet	B	C-2F	.56	1.07	7,500	9
27	456	Instrument	28.0	17A	2.0	Miniature Bayonet	B	C-2F	.56	1.07	5,000	9

(3) Useful hours.

(13) Supported.

(14) This lamp is specially designed for a particular purchaser and may not be suitable for other uses because of its excessive wattage requirements for the bulb size. Consult the nearest GE Lamp Sales Office for application information.

(69) Not recommended for new OEM applications—suggested for new

(70) These lamps produce a random flashing indication only. While the majority should flash between 40-160 flashes per minute at normal room temperature, some will be outside this range. As ambient temperature and/or input voltage changes, the flash rate may vary considerably. At rated voltage and room temperature most lamps will flash within 60 seconds

(116) Life tests are performed on DC voltage only.

(120) This lamp is specially designed for a particular purchaser and may not be suitable for other uses because of its non-ferrous color coating.



# Miniature Lamp Specifications

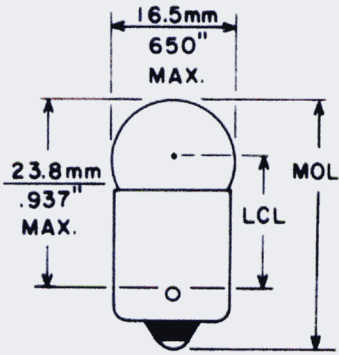

Fig. 11  
G-5

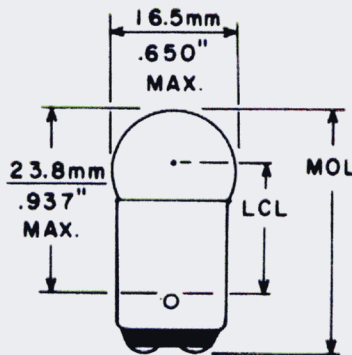

Fig. 13  
G-5

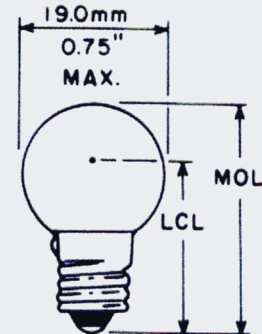

Fig. 15  
G-6

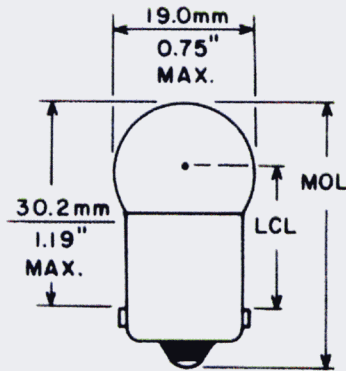

Fig. 16  
G-6

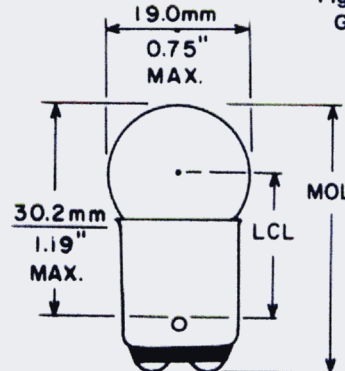

Fig. 17  
G-6

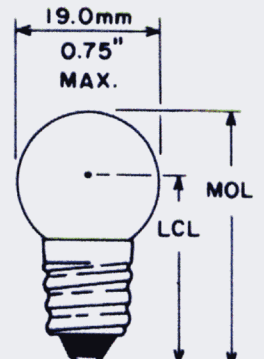

Fig. 18  
G-6

Line No.	GE Lamp No.	Primary Application	Design Volts	Design Watts or Amps	Mean Spherical Candle-Power (Approx.)	Base	Atmosphere B-Vac./C-Gas	Filament Designation	Light Center Length (Inches)	Max. Overall Length (Inches)	Rated Average Lab Life (Hours)	Fig. No.
----------	-------------	---------------------	--------------	----------------------	---------------------------------------	------	-------------------------	----------------------	------------------------------	------------------------------	--------------------------------	----------

## G-5 BULB $\frac{5}{8}$ " (16mm) DIAMETER

1	1315	Aircraft Emergency Lighting	2.5	1.00A	1.75	S.C. Bayonet	C	C-6	.69	1.25	20 <sup>(116)</sup>	11
2	301	Aircraft	28.0	.17A	3.0	S.C. Bayonet	B	C-2F	.69	1.25	500	11
3	302	Aircraft	28.0	.17A	3.0	D.C. Bayonet	B	C-2F	.69	1.25	500	13

## G-6 BULB $\frac{3}{4}$ " (19mm) DIAMETER

4	157	Medical <sup>(8)</sup>	5.8	1.10A	8.1	Miniature Screw	C	C-2R	1.0 <sup>(127)</sup>	1.22	50	15
5	81	Auto, Aircraft, and Coin Machine	6.5	1.02A	6.0	S.C. Bayonet	C	C-2R	.75	1.44	500	16
6	82	Auto and Marine	6.5	1.02A	6.0	D.C. Bayonet	C	C-2R	.75	1.44	500	17
7	63	Coin Machine	7.0	.63A	3.0	S.C. Bayonet	C	C-2R	.75	1.44	1,000	16
8	64	Aircraft and Marine	7.0	.63A	3.0	D.C. Bayonet	C	C-2R	.75	1.44	1,000	17
9	89	Auto	13.0	.58A	6.0	S.C. Bayonet	C	C-2R	.75	1.44	750	16
10	90	Auto and Marine	13.0	.58A	6.0	D.C. Bayonet	C	C-2R	.75	1.44	750	17
11	98	Auto, Heavy Duty	13.0	.62A	6.0	S.C. Bayonet	C	C-2V	.75	1.44	800	16
12	67	Auto	13.5	.59A	4.0	S.C. Bayonet	C	C-2R	.81	1.44	5,000 <sup>(4)</sup>	16
13	68	Auto and Marine	13.5	.59A	4.0	D.C. Bayonet	C	C-2R	.81	1.44	5,000 <sup>(4)</sup>	17
14	1155	Auto, Truck Marker — Heavy Duty	13.5	.59A	4.0	S.C. Bayonet	C	2C-2R	.81	1.44	(158) <sup>(4)</sup>	16
15	97	Auto — Heavy Duty	13.5	.69A	4.0	S.C. Bayonet	C	C-2V <sup>(13)</sup>	.81	1.44	(158) <sup>(4)</sup>	16
16	97A	Auto, Sidemarker — Outside Translucent Amber (yellow) Coating — Heavy Duty	13.5	.69A	—	S.C. Bayonet	C	C-2V <sup>(13)</sup>	—	1.44	(158) <sup>(4)</sup>	16
17	631	Auto — Two identical filaments in series — Heavy Duty	14.0	.63A	6.0	S.C. Bayonet	C	2C-2R	.75	1.44	1,000	16
18	509K	Indicator <sup>(72)</sup>	24.0	.18A	2.8	Candelabra Screw	B	C-2F	.94	1.38	1,000	18
19	1251	Instrument — Two identical supported filaments in series	28.0	.23A	3.0	S.C. Bayonet	B	2C-2V <sup>(13)</sup>	.75	1.44	2,000	16
20	1252	Instrument — Two identical supported filaments in series	28.0	.23A	3.0	D.C. Bayonet	B	2C-2V <sup>(13)</sup>	.75	1.44	2,000	17
21	303	Aircraft	28.0	.30A	6.0	S.C. Bayonet	B	C-2F	.75	1.44	500	16
22	304	Aircraft	28.0	.30A	6.0	D.C. Bayonet	B	C-2F	.75	1.44	500	17
23	623	Instrument — Two identical supported filaments in series	28.0	.37A	6.0	S.C. Bayonet	B	2C-2V <sup>(13)</sup>	.75	1.44	1,000	16
24	624	Marine — Two identical supported filaments in series	28.0	.37A	6.0	D.C. Bayonet	B	2C-2V <sup>(13)</sup>	.75	1.44	1,000	17
25	1224	Marine	34.0 <sup>(147)</sup>	.16A	3.8	D.C. Bayonet	B	C-2F	.69	1.44	500	17

<sup>(4)</sup> At 14 volts.

<sup>(8)</sup> Bulb top selected for minimum glass imperfections.

<sup>(13)</sup> Supported.

household circuits. The bulb may shatter if used in circuits of 110-120 volts or higher.

<sup>(116)</sup> Life tests are performed on DC voltage only.

# Miniature Lamp Specifications

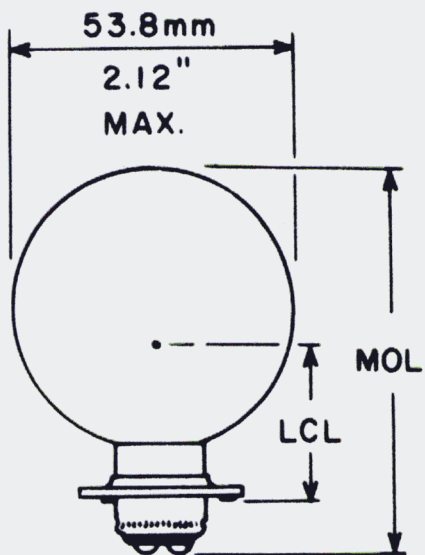

Fig. 22  
G-16 $\frac{1}{2}$

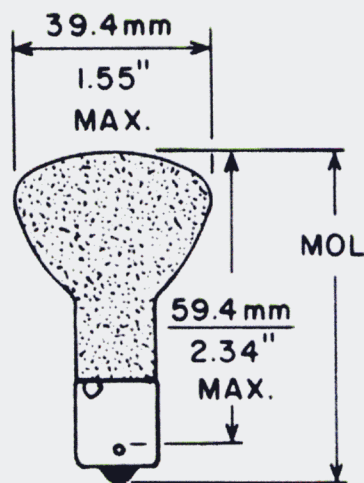

Fig. 23  
R-12

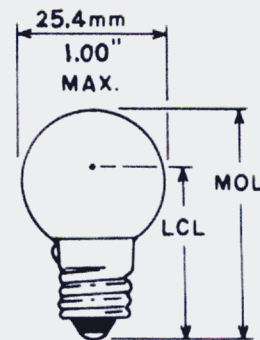

Fig. 24  
G-8

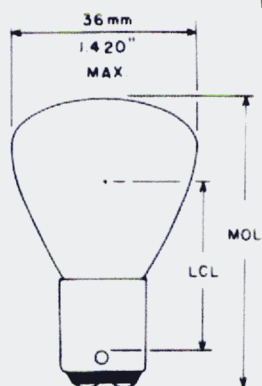

Fig. 25  
RP-11

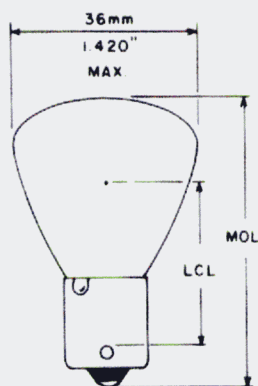

Fig. 26  
RP-11

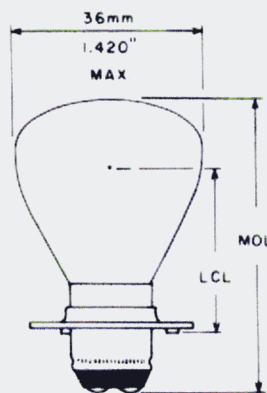

Fig. 27  
RP-11

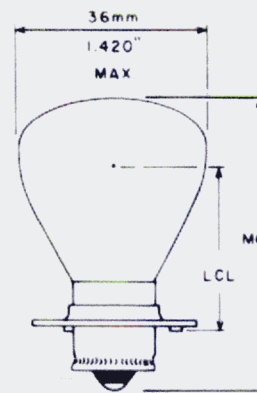

Fig. 27a  
RP-11

Line No.	GE Lamp No.	Primary Application	Design Volts	Design Watts or Amps	Mean Spherical Candle-Power (Approx.)	Base	Atmosphere B-Vac./C-Gas	Filament Designation	Light Center Length (Inches)	Max. Overall Length (Inches)	Rated Average Lab Life (Hours)	Fig. No.
<b>G8 BULB 1" (25.4mm) DIAMETER</b>												
1	809M	Instrument	70.0	.12A	0.8	Min Screw	B	C-7A	1.31	1.8	600	24
<b>G16<math>\frac{1}{2}</math> BULB 2<math>\frac{1}{8}</math>" (52mm) DIAMETER Burning position — base down to horizontal, except as noted.</b>												
2	1240	Special Service <sup>(73)</sup>	32.0	3.6A	250	D.C. Pf. (A)	C	CC-6	1.12	3.0	35	22
<b>R-12 BULB 1<math>\frac{1}{2}</math>" (38mm) DIAMETER</b>												
3	1383	Auto, Reading Light — Base half of bulb reflectorized <sup>(21)</sup>	13.0	20W	—	S.C. Bayonet	C	C-8	—	2.63	300	23
4	1388	Special Service, Telephone Trouble — Base half of bulb reflectorized.				D.C. Bayonet	C	CC-8				
5	1385	Special Service, Reading Light — Base half of bulb reflectorized <sup>(21)</sup>	24.0	20W	—	D.C. Bayonet	C	CC-8	—	2.63	500	—
			28.0	20W	—	S.C. Bayonet	C	CC-8	—	2.63	300	23
<b>RP-11 BULB 1<math>\frac{3}{8}</math>" (35mm) DIAMETER Burning position — base down to horizontal, except as noted.</b>												
6	2331	Instrument <sup>(73)</sup>	5.9	4.66A	32	D.C. Pf. (S)	C	C-6	1.18	2.25	400	27
7	2338	Instrument — High temperature solder <sup>(73)</sup>	6.2	4.49A	32		C	C-6				
8	1503	Instrument <sup>(73)</sup>	5.9	4.66A	32	D.C. Pf. (S)	C	C-6	1.18	2.25	400	27
9	1209	Instrument <sup>(73)</sup>	5.9	6.53A	50	S.C. Pf. (B)	C	C-2V	.88	2.25	200	27A
10	1133	Instrument <sup>(73)</sup>	6.1	4.1A	32	S.C. Pf. (B)	C	C-6	.88	2.25	125	27A
11	1195	Auto — Nickel-plated base <sup>(73)</sup>	6.2	3.91A	32	S.C. Bayonet	C	C-2R	1.25	2.25	200	26
12	1196	Auto <sup>(73)</sup>	12.5	3.00A	50	S.C. Bayonet	C	C-2V <sup>(13)</sup>	1.25	2.25	300	26
13	1047	Aircraft <sup>(73)</sup>	12.5	3.00A	50	D.C. Bayonet	C	C-2V <sup>(13)</sup>	1.25	2.25	300	25
14	1062	Special Service, Emer. Ltg. <sup>(73)</sup>	26.0	2.70A	105	S.C. Bayonet	C	2CC-6	1.25	2.25	300	26
			40.0	.92A	50	D.C. Bayonet	C	C-5	1.25	2.25	100	25

<sup>(13)</sup> Supported.

<sup>(21)</sup> Top of bulb light outside frosted.

<sup>(73)</sup> CAUTION: While this lamp is carefully inspected before shipment, the glass bulb may crack when subjected to abnormal pressure. Therefore, it is recommended that the bulb be grasped with a cloth or glove when removing or installing the lamp in a tight fitting socket.



# Miniature Lamp Specifications

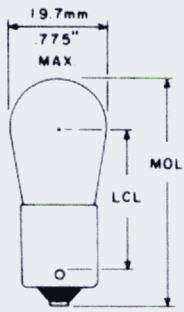

Fig. 28  
S-6

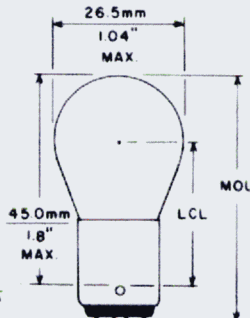

Fig. 30  
S-8

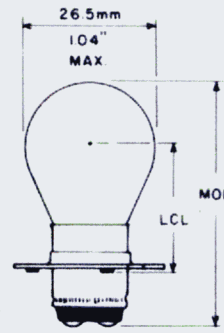

Fig. 32  
S-8

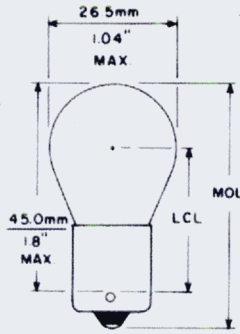

Fig. 29  
S-8

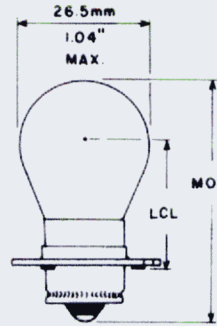

Fig. 31  
S-8

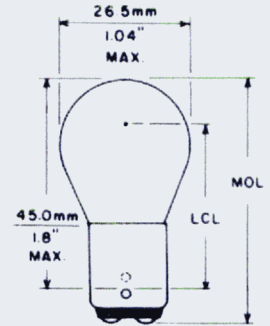

Fig. 33  
S-8

Line No.	GE Lamp No.	Primary Application	Design Volts	Design Watts or Amps	Mean Spherical Candle-Power (Approx.)	Base	Atmosphere B-Vac./C-Gas	Filament Designation	Light Center Length (Inches)	Max. Overall Length (Inches)	Rated Average Lab Life (Hours)	Fig. No.
----------	-------------	---------------------	--------------	----------------------	---------------------------------------	------	-------------------------	----------------------	------------------------------	------------------------------	--------------------------------	----------

## S-6 BULB 3/4" (19mm) DIAMETER

1	2576	Pin Spotter	3.5	2.50A	6.5	Wire Terminal	C	C6	—	1.75	2,500	—
2	2577	Pin Spotter	3.5	2.50A	6.5	S.C. Bayonet	C	C6	1.12	1.75	2,500	28
3	1424	Instrument, Photocell										
4	1440	Exciter — Silver Contact <sup>(8)</sup> Special Service	3.7 4.0	2.75A 4.00A	11 20	S.C. Bayonet	C	C-6	1.12	1.81	100 50	28 —
5	1534	Aircraft <sup>(15)(69)(144)</sup>	4.0 5.0 28.0	1.00A .55A .34A	3.7 2 6	D.C. Index D.C. Index	C C	C-6 C-6	.38 1.12	1.72 1.82	275 50 1,000 <sup>(75)</sup>	— — —

## S-8 BULB 1" (25mm) DIAMETER

6	1651	Hand Lantern — 4F or 8F Cells in series parallel	5.0	.60A	3	S.C. Bayonet	C	C-2R	1.12	2.0	20 <sup>(116)</sup>	29
7	1565	Instrument, Photoelectric scanner <sup>(7)</sup>	5.1	1.75A	4.8	S.C. Pf. (S)	C	C-81	1.00	2.0	5,000+	31
8	1612	Instrument (L.C.L. & A.A. tol. + 3/64") <sup>(7)</sup>	5.4	1.90A <sup>(147)</sup>	10	D.C. Bayonet	C	C-6	1.25	2.0	1,000	30
9	1680	Aircraft	6.0	4.10A	32	S.C. Bayonet	C	C-6	1.25	2.0	300	29
10	1680X	Aircraft — Solid Silver Contact	6.0	4.10A	32	S.C. Bayonet	C	C-6	1.25	2.0	300	29
11	1096	Instrument, Microscope Illuminator <sup>(7)</sup>	6.0	4.50A	30	D.C. Pf. (S)	C	HORIZ C-2R	1.00	2.0	500	32
12	1468	Medical Instrument — Burning position base up to horiz. <sup>(7)</sup>	6.0	4.50A	30	D.C. Pf. (S)	C	C-2R	1.25	2.0	500	32
13	1468X	Medical Instrument — Burning position base up to horiz.	6.0	4.50A	30	D.C. Pf. (S)	C	C-2R	1.25	2.0	500	32
14	1594	Instrument, Microscope base down to horiz. <sup>(7)</sup>	6.0	5.00A	36	D.C. Bayonet	C	C-6	1.25	2.0	250	30
15	1129	Special Service	6.4	2.63A	21	S.C. Bayonet	C	C-6	1.25	2.0	200	29
16	1154	Auto Stop, Tail, Signal	6.4 7.0	2.63A .75A	21 3	S.C. Bayonet D.C. Index	C C	C-6 C-6	1.25	2.0	200 1,000	29 33
17	6	Special Service, Sewing Machine	6.4	3.0A	23	D.C. Bayonet	C	C-2R	1.25	2.0	500	30
18	1460	Medical <sup>(7)</sup>	6.5	2.75A	23	D.C. Pf. (A)	C	C-6	1.25	2.0	100	32
19	1460X	Microscope Illuminator — Silver contacts <sup>(7)</sup>	6.5	2.75A	23	D.C. Pf. (A)	C	C-6	1.25	2.0	100	32
20	1493	Instrument, Microscope Illuminator (L.C.L. & A. A. tol + 3/64") <sup>(7)</sup>	6.5	2.75A	23	D.C. Bayonet	C	C-6	1.12	2.0	100	30
21	1630	Instrument, Microscope Illuminator <sup>(7)</sup>	6.5	2.75A	23	D.C. Pf. (A)	C	C-6	1.00	2.0	100	32
22	1631X	Instrument, Colorimeter — Silver contacts <sup>(7)</sup>	6.5	2.75A	23	D.C. Pf. (A)	C	C-6	1.00	2.0	100	32
23	1649	Instrument, Microscope Illuminator — Rect.-shaped filament <sup>(8)</sup>	6.5	2.75A	23	D.C. Pf. (A)	C	FC-6Z	1.25	2.0	100	32
24	1619	Instrument <sup>(7)</sup>	6.7	1.90A	15	S.C. Bayonet	C	C-6	1.12	2.0	500	29
25	88	Indicator	6.8	1.91A	15	D.C. Bayonet	C	C-6	1.12	2.0	300	30

<sup>(7)</sup> Entire bulb selected for minimum glass imperfections.

<sup>(8)</sup> Bulb top selected for minimum glass imperfections.

<sup>(15)</sup> This lamp is specially designed for a particular purchaser and may not be suitable for other uses because of its limited mechanical strength. Consult the nearest GE Lamp Sales Office for application information.

<sup>(69)</sup> Not recommended for new OEM applications—suggested for new

<sup>(75)</sup> Estimated. Based on limited test information.

<sup>(116)</sup> Life tests are performed on DC voltage only.

<sup>(144)</sup> Potentially limited availability in large quantities at certain times of the year. Contact your GE Lamp Representative for current availability information.

<sup>(147)</sup> Differs from ANSI.

# Miniature Lamp Specifications

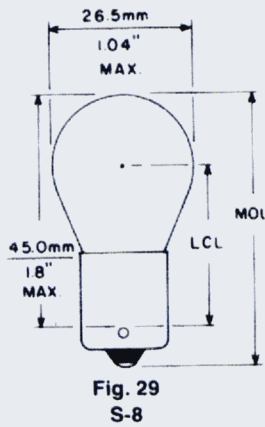

Fig. 29  
S-8

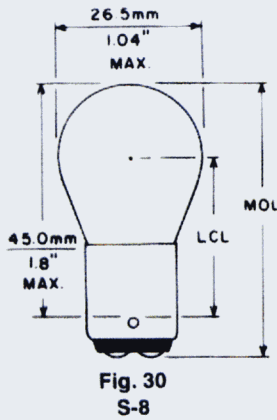

Fig. 30  
S-8

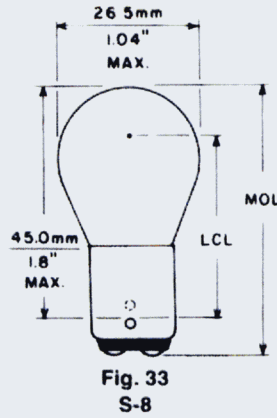

Fig. 33  
S-8

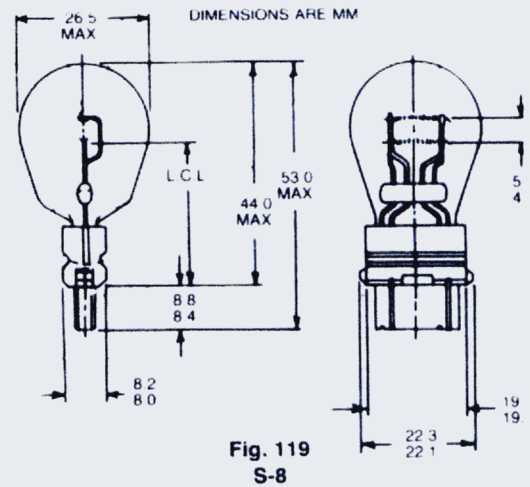

Fig. 119  
S-8

Line No.	GE Lamp No.	Primary Application	Design Volts	Design Watts or Amps	Mean Spherical Candle-Power (Approx.)	Base	Atmosphere B-Vac./C-Gas	Filament Designation	Light Center Length (Inches)	Max. Overall Length (Inches)	Rated Average Lab Life (Hours)	Fig. No.
----------	-------------	---------------------	--------------	----------------------	---------------------------------------	------	-------------------------	----------------------	------------------------------	------------------------------	--------------------------------	----------

## S-8 BULB 1" (25mm) DIAMETER (continued)

1	93	Auto	12.8	1.04A	15	S.C. Bayonet	C	C-6 <sup>(147)</sup>	1.12	2.0	700	29
2	94	Auto and Marine	12.8	1.04A	15	D.C. Bayonet	C	C-6 <sup>(147)</sup>	1.12	2.0	700	30
3	2031	Auto/Truck	12.8	1.14	21	Wire Terminal	C	C-6	—	1.75	500	—
4	1152	Special Service <sup>(7)</sup>	12.8	1.34A	21	D.C. Bayonet	C	C-2R	1.25	2.0	500	30
5	1176	Auto Stop, Tail, Signal	12.8	1.34A	21			C-6			300	
6	1141	Auto	12.8	1.44A	21	D.C. Bayonet	C	C-6	1.25	2.0	1,500	30
7	1142	Auto	12.8	1.44A	21	S.C. Bayonet	C	C-6	1.25	2.0	1,000	29
8	1777	Aircraft Tail Light	12.8	1.52A	26	D.C. Bayonet	C	C-6	1.25	2.0	1,000	30
9	1034	Auto Stop Tail Signal	12.8	1.80A	32	S.C. Bayonet	C	C-2R	1.12	2.0	400	29
			14.0	.59A	3	D.C. Index	C	C-6	1.25	2.0	200	33
10	1073	Auto Signal	12.8	1.80A	32	D.C. Index	C	C-6	1.25	2.0	5,000	33
11	1076	Auto	12.8	1.80A	32	S.C. Bayonet	C	C-6	1.25	2.0	200	29
12	1156	Auto/Truck Signal — Heavy Duty	12.8	2.10A	32	D.C. Index	C	C-6	1.25	2.0	1,200	29
13	1156NA	Auto Natural Amber	12.8	2.10A	24	S.C. Bayonet	C	C-6	1.25	2.0	1,200	29
14	2057	Auto Stop, Signal — Heavy Duty	12.8	2.10A	32			C-6			1,200	
			14.0	.48A	2	D.C. Index	C	C-6	1.25	2.0	5,000	33
15	2057NA	Auto Signal, Park-Natural Amber (yellow) — Heavy Duty	12.8	2.10A	24	D.C. Index	C	C-6	1.25	2.0	1,200	33
16	2058U	Auto/Truck Stop, Signal	12.8	2.10A	32	D.C. Index	C	C-6	1.25	2.0	5,000	33
			14.0	.48A	2	Wire Terminal <sup>(113)</sup>	C	C-6	—	1.81	5,000	—
17	3155	Auto Signal	12.8	1.60A	21	Plastic Wedge	C	C-6	1.10	2.09	1,500	119
18	3157	Auto Stop, Signal-Heavy Duty	12.8	2.10A	32			C-6			1,200	119
			14.0	.48A	2	Plastic Wedge	C	C-6	1.10	2.09	5,000	—
19	3157NA	Auto Signal Park-Natural Amber	12.8	2.10A	24			C-6			1,200	119
			14.0	.48A	1.5	Plastic Wedge	C	C-6	1.10	2.09	5,000	—
20	3057	Auto Stop, Signal-Heavy Duty	12.8	2.10A	32			C-6			1,200	119
			14.0	.59A	3	Plastic Wedge	C	C-6	1.10	2.09	5,000	—
21	3057NA	Auto Signal, Park-Natural Amber	12.8	2.10A	24			C-6			1,200	119
			14.0	.59A	2.2	Plastic Wedge	C	C-6	1.10	2.09	5,000	—
22	1157	Auto/Truck Stop, Signal — Heavy Duty	12.8	2.10A	32			C-6			1,200	—
			14.0	.59A	3	D.C. Index	C	C-6	1.25	2.0	5,000	33
23	1157A	Auto Signal, Park <sup>(132)</sup> — Outside Translucent Amber (yellow) coating — Heavy Duty — Not rec. for new appli. <sup>(132)</sup>	12.8	2.10A	—			C-6			1,200	—
			14.0	.59A	—	D.C. Index	C	C-6	—	2.0	5,000	33
24	1157NA	Auto Signal Park — Natural Amber (yellow) — Heavy Duty	12.8	2.10A	24			C-6			1,200	—
			14.0	.59A	2.2	D.C. Index	C	C-6	1.25	2.0	5,000	33
25	2242	Auto/Truck Stop, Signal — Heavy Duty	12.8	2.10A	32			C-6			1,200	—
			14.0	.59A	3	Wire Terminal <sup>(113)</sup>	C	C-6	—	1.81	5,000+	—

(7) Entire bulb selected for minimum glass imperfections.

(113) This is a flange seal wire terminal lamp. When unbased lamps such as these are handled and wired into a device, damage can be kept to a minimum by avoiding excessive tensile strain on the lead wires.

touching the glass is compatible in thermal expansion; and by avoiding excessive tensile strain on the lead wires.

(132) Paint may peel, craze or discolor when subjected to excessive moisture, heat, and freezing in housings with plugged drain holes or which other-



# Miniature Lamp Specifications

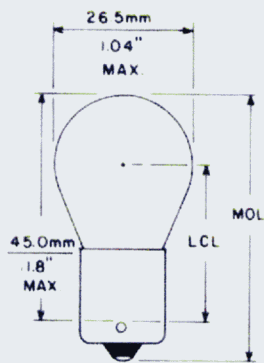

Fig. 29  
S-8

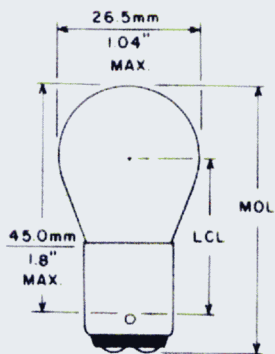

Fig. 30  
S-8

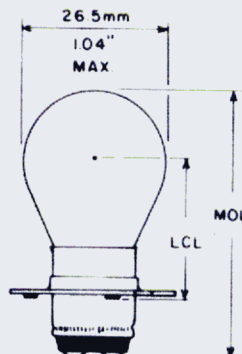

Fig. 32  
S-8

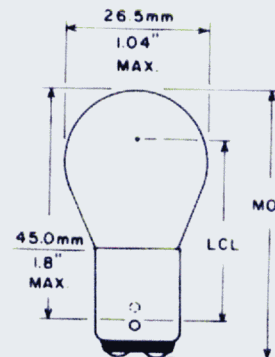

Fig. 33  
S-8

Line No.	GE Lamp No.	Primary Application	Design Volts	Design Watts or Amps	Mean Spherical Candle-Power (Approx.)	Base	Atmosphere B-Vac./C-Gas	Filament Designation	Light Center Length (Inches)	Max. Overall Length (Inches)	Rated Average Lab Life (Hours)	Fig. No.
S-8 BULB 1" (25mm) DIAMETER (continued)												
1	2357	Auto Stop, Signal-Heavy Duty	12.8	2.20A	40			C-6				
2	2357NA	Auto/Truck Stop/Signal, Natural Amber, Heavy Duty	14.0	59A	3	D.C. Index	C	C-6	1.25	2.0	400	33
3	2144	Auto/Truck	12.8	2.20A	30	D.C. Index	C	C-6	1.25	2.0	5,000	
4	2396	Auto Stop Lamp	12.8	2.10A	32	Wire Terminal	C	C-6	—	1.75	600	
5	198	Truck Stop, Signal — Heavy Duty <sup>(110)</sup>	12.8	2.23A	40	S.C. Bayonet	C	C-6	1.25	2.0	400	
			12.8	2.25A <sup>(142)</sup>	32			C-6			1,200	
6	199	Truck Signal — Heavy Duty <sup>(110)</sup>	14.0	59A	3	D.C. Index	C	C-6	1.25	2.0	5,000+	33
7	P25-1	Auto — European (ECE P21W)	12.8	2.25A	32	S.C. Bayonet	C	C-6	1.25	2.0	1,200	29
8	P25-2	Auto Stop, Signal — European (ECE P21/5W)	13.5	1.86A	36.6	S.C. Bayonet	C	C-6	31.8mm	52.5mm	250	
			13.5	1.86A	35			C-6			250	
				.44A	2.78	D.C. Index	C	C-6	31.8mm	52.5mm	1,000	
9	1634	Instrument, Microscope Illuminator — Burn base up to horiz. <sup>(8)</sup>	20.0	1.00A	24	D.C. Pf (A)	C	CC-6	1.25	2.0	200	32
10	305	Aircraft	28.0	51A	15	S.C. Bayonet	C	C-2V <sup>(13)</sup>	1.12	2.0	300	29
11	305AF	Aircraft — All frosted	28.0	51A	—	S.C. Bayonet	C	C-2V <sup>(13)</sup>	—	2.0	300	29
12	306	Aircraft	28.0	51A	15	D.C. Bayonet	C	C-2V <sup>(13)</sup>	1.12	2.0	300	30
13	705	Aircraft	28.0	51A	15	S.C. Bayonet	C	CC-6	1.12	2.0	900	29
14	1591	Auto	28.0	61A	15	S.C. Bayonet	C	C-2V <sup>(13)</sup>	1.12	2.0	1,000	29
15	1591AF	Aircraft — All frosted	28.0	61A	—	S.C. Bayonet	C	C-2V <sup>(13)</sup>	—	2.0	1,000	29
16	1691	Aircraft — 2 identical filaments in series	28.0	61A	15	S.C. Bayonet	C	C-2V <sup>(13)</sup>	—	2.0	1,000	29
17	1691AF	Aircraft — All frosted — 2 identical filaments in series	28.0	61A	—	S.C. Bayonet	C	2C-2R	—	2.0	1,000	29
18	1692	Marine — 2 identical filaments in series	28.0	61A	15	D.C. Bayonet	C	2C-2R	1.12	2.0	1,000	30
19	2232	Aircraft — Spiral lead	28.0	.643A	18	S.C. Bayonet	C	CC-8	1.19	2.0	2,000	29
20	2232SB	Aircraft — Spiral lead Top of bulb reflectorized	28.0	.643A	—	S.C. Bayonet	C	CC-8	1.19	2.0	2,000	29
21	307	Aircraft	28.0	67A	21	S.C. Bayonet	C	C-2V <sup>(13)</sup>	1.12	2.0	300	29
22	307AF	Aircraft — All frosted	28.0	67A	—	S.C. Bayonet	C	C-2V <sup>(13)</sup>	—	2.0	300	29
23	307R	Aircraft — Outside coated red (silicate)	28.0	67A	—	S.C. Bayonet	C	C-2V <sup>(13)</sup>	—	2.0	300	29
24	307SB	Aircraft — Reflectorized bowl	28.0	67A	—	S.C. Bayonet	C	C-2V <sup>(13)</sup>	1.12	2.0	300	29
25	308	Aircraft	28.0	67A	21	D.C. Bayonet	C	C-2V <sup>(13)</sup>	1.12	2.0	300	30
26	308AF	Aircraft — All frosted	28.0	67A	—	D.C. Bayonet	C	C-2V <sup>(13)</sup>	—	2.0	300	30
27	1203	Special Service	28.0	71A	21	S.C. Bayonet	C	C-2V <sup>(13)</sup>	1.25	2.0	400	29
28	2233	Aircraft — Spiral Lead	28.0	.766A	21	S.C. Bayonet	C	CC-8	1.19	2.0	2,000	29
29	1563	Military Headlamp — Blackout	28.0	.76A	21	S.C. Bayonet	C	CC-6	1.12	2.0	1,000	29
30	1665	Aircraft	28.0	80A	21	S.C. Bayonet	C	C-2V <sup>(13)</sup>	1.12	2.0	1,000	29
31	1665AF	Aircraft — All frosted	28.0	80A	—	S.C. Bayonet	C	C-2V <sup>(13)</sup>	—	2.0	1,000	29
32	315	Aircraft	28.0	90A	32	S.C. Bayonet	C	C-2V <sup>(13)</sup>	1.12	2.0	300	29

<sup>(8)</sup> Bulb top selected for minimum glass imperfections.

<sup>(13)</sup> Supported.

<sup>(110)</sup> To be used with variable load flasher in applications where bulb outage

senger vehicle 80 or more inches in overall width, on a truck that is capable of accommodating a slide-in camper, or any vehicle equipped to tow trailers. Flash rate may be altered if used with incorrect fixed load flasher.

# Miniature Lamp Specifications

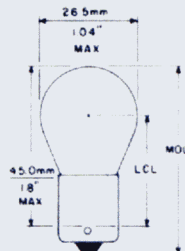

Fig. 29  
S-8

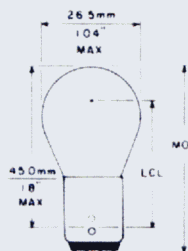

Fig. 33  
S-8

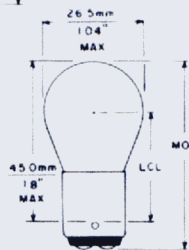

Fig. 30  
S-8

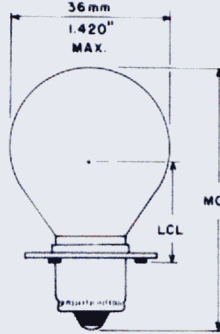

Fig. 34  
S-11

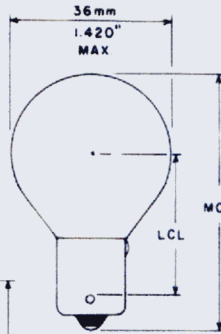

Fig. 35  
S-11

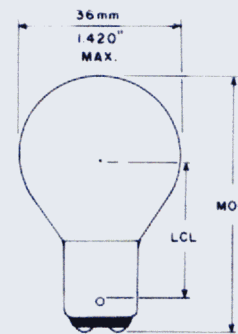

Fig. 36  
S-11

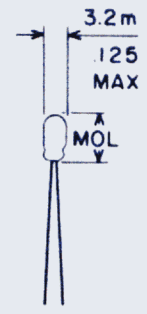

Fig. 37  
T-1

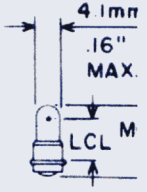

Fig. 38  
T-1

Line No.	GE Lamp No.	Primary Application	Design Volts	Design Watts or Amps	Mean Spherical Candle-Power (Approx.)	Base	Atmosphere B-Vac./C-Gas	Filament Designation	Light Center Length (Inches)	Max. Overall Length (Inches)	Rated Average Lab Life (Hours)	Fig No
S-8 BULB 1" (25mm) DIAMETER (continued)												
1	2155	Truck <sup>(15)</sup>	28.0	.93A	32	Wire Terminal		CC-6	—	1.75	400	—
2	1580X	Instrument <sup>(7)</sup>	28.0	.34A	6	S.C. Bayonet	C	C-2V <sup>(13)</sup>	—	2.0	1,000	—
3	1662	Aircraft — C-2V Filament inverted Burn base down to horizontal <sup>(15)(33)(144)</sup>	28.0	.93A	32	D.C. Index	C	CC-6	1.25	2.0	400	29
4	1683	Aircraft — 2 identical filaments in series	28.0	.34A	6	D.C. Index	C	C-2V <sup>(13)</sup>	1.25	2.0	1,000	33
5	1638	Marine — 2 identical filaments in series	28.0	1.02A	32	S.C. Bayonet	C	2C-6	1.25	2.0	500	29
6	1229	Special Service, Emergency Lighting	40.0	.38A	15	D.C. Bayonet	C	2C-6	1.25	2.0	500	30
						D.C. Bayonet	C	C-2V <sup>(13)</sup>	1.12	2.0	400	30

## S-11 BULB 3/8" (35mm) DIAMETER

7	2759	Instrument <sup>(7)</sup>	6.1	4.10A	35	S.C. Pf (B)	C	C-8Z	.88	2.38	125	34
8	1763	Instrument, Colorimeter <sup>(7)</sup>	6.1	4.10A	32	S.C. Pf (B)	C	C-6	.88	2.38	1,500	34
9	1561	Instrument, Colorimeter <sup>(7)</sup>	6.3	4.00A	24	S.C. Pf (B)	C	C-8Z	.88	2.38	1,500	34
10	1731	Instrument — Silver Contact — Burn base down to horizontal <sup>(7)</sup>	6.3	6.60A	47	S.C. Pf (B)	C	C-6	.88	2.38	1,000	34
11	1726X	Aircraft Gunsight — Bulb reflectorized — 1/32" clear spot on back <sup>(135)</sup>	12.5	3.00A	—	D.C. Bayonet	C	3C-6	1.28	2.38	300	3E
12	309	Aircraft	28.0	.90A	32	S.C. Bayonet	C	C-2V <sup>(13)</sup>	1.25	2.38	300	3E
13	309AF	Aircraft — All frosted	28.0	.90A	—	S.C. Bayonet	C	C-2V <sup>(13)</sup>	—	2.38	300	3E
14	310	Aircraft	28.0	.90A	32	D.C. Bayonet	C	C-2V <sup>(13)</sup>	1.25	2.38	300	3E
15	311	Aircraft	28.0	1.29A	50	S.C. Bayonet	C	C-2V <sup>(13)</sup>	1.25	2.38	300	3E
16	311R	Aircraft — Outside coated red (Silicate)	28.0	1.29A	—	S.C. Bayonet	C	C-2V <sup>(13)</sup>	—	2.38	300	3E
17	3011	Aircraft	28.0	1.29A	44	S.C. Bayonet	C	C-2V <sup>(13)</sup>	1.25	2.38	1,000	3E

## T-1 BULB 1/8" (3mm) DIAMETER

18	680	Aircraft — 1" minimum tinned leads	5.0	.06A	.03 ± 25%	Wire Terminal <sup>(122)</sup>	B	C-2R	—	.25	60,000 <sup>(75)(79)</sup>	37
19	683	Aircraft — 1" minimum tinned leads	5.0	.06A	.05 ± 25%	Wire Terminal <sup>(122)</sup>	B	C-2R	—	.25	40,000 <sup>(79)</sup>	3E
20	685	Aircraft	5.0	.06A	.05 ± 25%	Sub-Midget Flanged	B	C-2R	.19	.38	40,000 <sup>(79)</sup>	3E
21	715	Aircraft — 1" minimum tinned leads	5.0	.115A	.15 ± 25%	Wire Terminal <sup>(122)</sup>	B	C-2R	—	.25	40,000 <sup>(75)(79)</sup>	37
22	718AS15	Aircraft — Aged and selected ± 15% C.P.	5.0	.115A	.15 ± 15%	Sub-Midget Flanged	B	C-2R	.19	.38	40,000 <sup>(75)(79)</sup>	3E

<sup>(7)</sup> Entire bulb selected for minimum glass imperfections.

<sup>(13)</sup> Supported.

<sup>(15)</sup> This lamp is specially designed for a particular purchaser and may not be suitable for other uses because of its limited mechanical strength. Consult the nearest GE Lamp Sales Office for application information.

<sup>(33)</sup> Connections of major and minor fil. to base are reversed from those for automotive lamps with Double Contact Index bases.

<sup>(75)</sup> Estimated. Based on limited test information.

<sup>(79)</sup> Life shown is AC voltage only. DC life will be approx. 50% of AC.

<sup>(122)</sup> This is a wire terminal lamp. The glass-to-metal seal (and tip where applicable) are susceptible to damage by thermal shock, and soldering or welding within 1/8" of the glass should be avoided as glass cracks and air leaks may develop. Solderability may be adversely affected by stor-

Lamps with tinned leads would not be subject to these storage restrictions. Nickel-plated leads are not recommended for soldering; however, their ability to be welded is not affected by these storage restrictions.

<sup>(135)</sup> **CAUTION:** This lamp is provided with an outside aluminized coating. This coating will conduct electricity and may be a shock hazard if (1) the "hot" (ungrounded) side of the line is energized and (2) the voltage is high enough to produce a shock. Never install or remove lamp unless "hot" side of line is turned off. These lamps should NOT be operated in series which may result in higher than design voltage at the lamp unless an electrical interlock is provided to make sure that "hot" side of line is off while servicing and lamps are so located that they cannot be touched when circuit is on.

<sup>(144)</sup> Potentially limited availability in large quantities at certain times of the



# Miniature Lamp Specifications

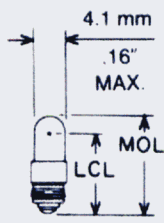

Fig. 39  
T-1/4

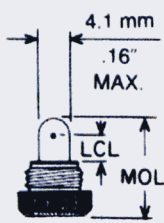

Fig. 40  
T-1/4

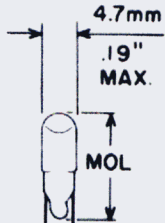

Fig. 42  
TL-1/2

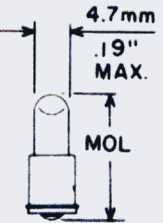

Fig. 44  
TL-1/2

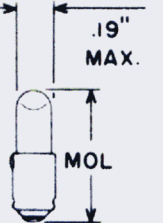

Fig. 45  
TL-1/2

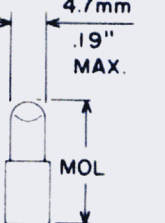

Fig. 46  
TL-1/2

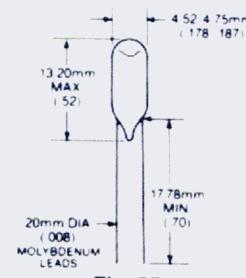
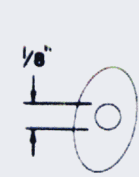
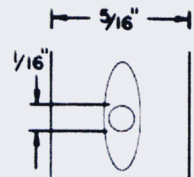

Fig. 95  
TL-1/2

## TYPICAL BEAM PATTERNS



LAMP #2124D



LAMP #252 #253

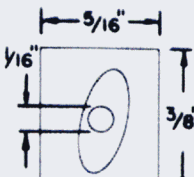

LAMP #253X

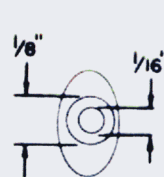

LAMP #261 #8261

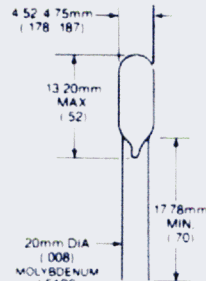

Fig. 96  
T-1/2

Line No.	GE Lamp No.	Primary Application	Design Volts	Design Watts or Amps	Mean Spherical Candle-Power (Approx.)	Base	Atmosphere B-Vac./C-Gas	Filament Designation	Light Center Length (Inches)	Max. Overall Length (Inches)	Rated Average Lab Life (Hours)	Fig. No.
<b>T-1/4 BULB 5/32" (4mm) DIAMETER</b>												
1	325	Aircraft	3.0	.19A	.25	Special <sup>(45)</sup>	B	C-2R	.44	.53	350	39
2	323	Aircraft	3.0	.19A	.25	Special <sup>(52)</sup>	B	C-2R	.18	.55	350	40
<b>T-1/2" (4.7mm) DIAMETER</b>												
3	3133	Instrument, Halogen <sup>(11)</sup>	2.5	.80A	1.6	Wire Terminal	C	C-6	.074	.038	20 <sup>(116)</sup>	96
4	2600	Instrument — Halogen <sup>(11)</sup>	3.5	.72A	2.9	Wire Terminal	C	C-6	—	.52	20 <sup>(116)</sup>	96
<b>TL-1/2 BULB 3/16" (4.7mm) DIAMETER</b>												
5	21240 <sup>(117)</sup>	Instrument — 5/8" leads — Min. beam 1/8" dia. at 3/8" from lens end	2.5	.35A	—	Wire Terminal <sup>(122)</sup>	B	C-2R	—	.57	10,000 <sup>(116)</sup>	42
6	252 <sup>(117)</sup>	Instrument, Lens End <sup>(53)(80)</sup>	2.5	.35A	—	S.C. Midget Flanged	B	C-2R	—	.69	10,000 <sup>(116)</sup>	44
7	253 <sup>(117)</sup>	Instrument, Lens End <sup>(53)(80)</sup>	2.5	.35A	—	Midget Grooved	B	C-2R	—	.69	10,000 <sup>(116)</sup>	45
8	253X <sup>(117)</sup>	Instrument, Lens End	2.5	.35A	—	Midget Grooved	B	C-2R	—	.69	10,000 <sup>(116)</sup>	45
9	261 <sup>(117)</sup>	Instrument, Lens End <sup>(58)(80)</sup>	2.5	.35A	—	Midget Grooved	B	C-2R	—	.69	10,000 <sup>(116)</sup>	45
10	8261 <sup>(117)</sup>	Instrument, Lens End <sup>(58)(80)</sup>	2.5	.35A	—	Bi-Pin M-23	B	C-2R	—	.65	10,000 <sup>(116)</sup>	46
11	3134	Instrument, Lens End, Halogen <sup>(11)</sup>	2.5	.80A	— <sup>(153)(140)</sup>	Wire Terminal	C	C-6	—	.44	20 <sup>(116)</sup>	95
12	2601	Instrument — Halogen, Lens End <sup>(11)</sup>	3.5	.72A	— <sup>(153)(154)</sup>	Wire Terminal	C	C-6	—	.52	20 <sup>(116)</sup>	95

(11) CAUTION: This halogen-cycle bulb could shatter if scratched or damaged. Use appropriate protection when handling, using, or disposing. Use in fixtures designed for the high temperature required for proper operation and that offer protection in case the bulb shatters. Turn power off when changing lamp. Allow lamp to cool before removal. For satisfactory performance: (1) limit seal and outer lead wire temperature to 350°C or lead wire deterioration may occur; (2) maintain a minimum bulb wall temperature of 250°C for operation of the halogen cycle; (3) operate at design volts; (4) if further processing of the leads, such as bending, welding, crimping, etc. is required, care must be taken to assure that the lamp seal area is not strained, cracked, chipped, or otherwise damaged or premature lamp failure may occur.

(45) Threaded base approximately 3/16" diameter by approximately 1/4" long.

(52) Light center length measured from open end of base to filament center. Three-part base with inner sleeve approximately 1/32" long, and with outer part of base threaded and knurled.

(53) Side solder within 25° of plane of filament. With lamp horizontal and side solder in uppermost position, the following beam pattern limits are provided on a surface perpendicular.

(58) Side solder within 25° plane of filament. With lamp horizontal and side solder in uppermost position, the following beam pattern limits are provided on a surface perpendicular to the base axis and located 3/8" from the end of bulb: 750 footcandles minimum over a 1/8" diameter circle centered on base axis. While entire beam may not be centered on base axis, it will fall within a rectangle 5/16" by 3/8" high whose center is on base axis. See beam pattern.

(80) Side solder within 25° plane of filament. With lamp horizontal and side solder in uppermost position, the following beam pattern limits are provided on a surface perpendicular to the base axis and located 3/8" from end of bulb: 750 footcandles minimum over a 1/8" diameter circle centered on base axis. While the entire beam may not be centered on base axis, it will cover at least a 1/8" circle centered on the base axis. See beam pattern.

(80) E.F.C. values will vary depending upon type of equipment used for measurement.

(116) Life tests are performed on DC voltage only.

(117) Listed with ANSI as TL-1/2 bulb.

(122) This is a wire terminal lamp. The glass-to-metal seal (and tip where applicable) are susceptible to damage by thermal shock, and soldering or welding within 1/8" of the glass should be avoided as glass cracks and air leaks may develop. Solderability may be adversely affected by storage for an extended period in excess of six months or by storage in a high humidity environment.

Lamps with tinned leads would not be subject to these storage restrictions. Nickel-plated leads are not recommended for soldering; however, their ability to be welded is not affected by these storage restrictions.

(140) At 3" from bulb end, beam should completely cover a 1/8" diameter circle and not extend outside a 3" diameter circle (both circles concentric and on bulb axis).

(153) Ft-candle maintenance may be less than 85% of initial readings at 70% of design life because of proximity of filament to lens.

(154) At 3" from bulb end, beam should completely cover a 1/8" diameter circle and not extend outside a 3" diameter circle (both circles concentric and

# Miniature Lamp Specifications

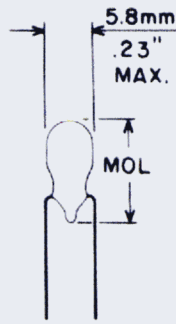

Fig. 49  
T-1<sup>3/4</sup>

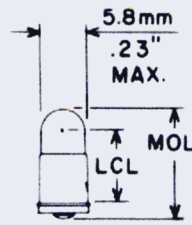

Fig. 50  
T-1<sup>3/4</sup>

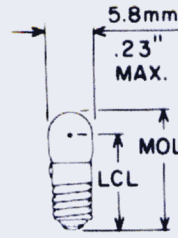

Fig. 51  
T-1<sup>3/4</sup>

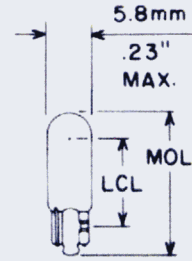

Fig. 52  
T-1<sup>3/4</sup>

Line No.	GE Lamp No.	Primary Application	Design Volts	Design Watts or Amps	Mean Spherical Candle-Power (Approx.)	Base	Atmosphere B-Vac./C-Gas	Filament Designation	Light Center Length (Inches)	Max. Overall Length (Inches)	Rated Average Lab Life (Hours)	Fig No
----------	-------------	---------------------	--------------	----------------------	---------------------------------------	------	-------------------------	----------------------	------------------------------	------------------------------	--------------------------------	--------

## T-1<sup>3/4</sup> BULB <sup>1/32</sup>" (5.5mm) DIAMETER

1	<b>251</b>	Indicator	2.47	.30A	45	S.C. Midget Flanged	R	C-2R	.38	.63	30 <sup>(116)</sup>	50
2	<b>268</b>	Instrument	2.5	.35A	20	S.C. Midget Flanged	B	C-2R	.44	.63	10,000 <sup>(116)</sup>	50
3	<b>56X</b>	Indicator	5.0	.115A	.15	Wedge <sup>(130)</sup>	B	C-2F	.40	.80	20,000 <sup>(75)(79)</sup>	52
4	<b>345</b>	Indicator	6.0	.04A	.04	S.C. Midget Flanged	B	C-2V	.38	.63	10,000 <sup>(79)</sup>	50
5	<b>328</b>	Aircraft	6.0	.20A	34 <sup>(10)</sup>	S.C. Midget Flanged	B	C-2R	.38	.63	1,000	50
6	<b>328</b>	Aircraft — Aged and selected										
	<b>AS-10</b>	±10% C.P.	6.0	.20A	34 <sup>(10)</sup>	S.C. Midget Flanged	B	C-2R	.38	.63	1,000	50
7	<b>79</b>	Indicator	6.0	.20A	.60	Wedge <sup>(130)</sup>	B	C-2R	.40	.80	1,000	50
8	<b>84</b>	Indicator	6.3	.04A	.03	Wedge <sup>(130)</sup>	B	C-2V	.40	.80	20,000 <sup>(79)</sup>	50
9	<b>2112D</b>	Indicator — Approx. <sup>1/8</sup> " leads — Yellow bead	6.3	.20A	.55	Wire Terminal <sup>(74)</sup>	B	C-2R	—	.52	10,000 <sup>(79)</sup>	40
10	<b>378</b>	Indicator	6.3	.20A	40	Midget Screw	B	C-2F	.52	.72	20,000 <sup>(43)(79)</sup>	50
11	<b>381</b>	Indicator	6.3	.20A	40	S.C. Midget Flanged	B	C-2F	.38	.63	20,000 <sup>(43)(79)</sup>	50
12	<b>86</b>	Indicator	6.3	.20A	40	Wedge <sup>(130)</sup>	B	C-2F	.40	.80	20,000 <sup>(79)</sup>	50
13	<b>1869D</b>	Indicator — Leads <sup>1/8</sup> " max. — Blue bead	10.0	.014A ± 10%	.006	Wire Terminal <sup>(74)</sup>	B	C-2F	—	.52	50,000 <sup>(116)</sup>	40
14	<b>344</b>	Indicator	10.0	.014A ± 10%	.006	S.C. Midget Flanged	B	C-2F	.38	.63	50,000 <sup>(116)</sup>	50
15	<b>394</b>	Indicator	12.0	.04A	.10	S.C. Midget Flanged	B	C-2F	.38	.63	10,000 <sup>(79)</sup>	50
16	<b>18</b>	Indicator	14.0	.04A	.13	Wedge	B	C-2F	.40	.80	5,000 <sup>(79)</sup>	50
17	<b>330</b>	Aircraft	14.0	.08A	.50	S.C. Midget Flanged	B	C-2F	.38	.63	1,500	50

<sup>(10)</sup> At 5 volts.

<sup>(43)</sup> Actual life depends upon use and environment. Theoretical design average life is 50,000 hours.

<sup>(61)</sup> Consult nearest GE Lamp Sales Office for application information.

<sup>(74)</sup> This butt seal wire terminal lamp is normally considered a subassembly. The glass-to-metal seal and glass tip are fragile. Therefore, any bending or soldering of the wire terminal closer than <sup>1/8</sup>" from the glass should be avoided since the bending or heat can cause leaks in the seal. Solderability may be adversely affected by storage for an extended period in excess of six months or by storage in a high humidity environment.

Lamps with tinned leads would not be subject to these storage restrictions.

<sup>(75)</sup> Estimated. Based on limited test information.

<sup>(79)</sup> Life shown is AC voltage only. DC life will be approx. 50% of AC.

<sup>(80)</sup> E.F.C. values will vary depending upon type of equipment used for measurement.

<sup>(116)</sup> Life tests are performed on DC voltage only.

<sup>(130)</sup> Subminiature wedge base lamps under 12 volts have copper-clad out lead wires to decrease contact resistance at the expense of corrosion resistance in severe environments.



# Miniature Lamp Specifications

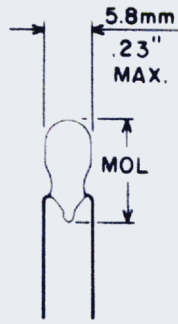

Fig. 49  
T-1 1/4

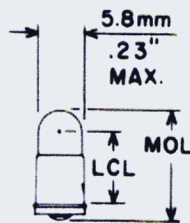

Fig. 50  
T-1 1/4

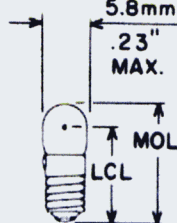

Fig. 51  
T-1 1/4

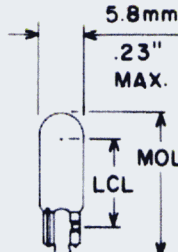

Fig. 52  
T-1 1/4

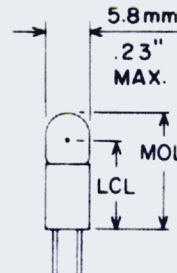

Fig. 53  
T-1 1/4

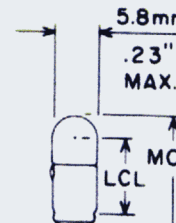

Fig. 54  
T-1 1/4

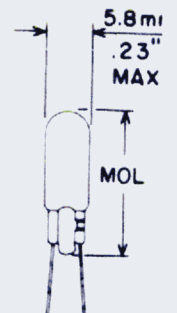

Fig. 55  
T-1 1/4

Line No.	GE Lamp No.	Primary Application	Design Volts	Design Watts or Amps	Mean Spherical Candle-Power (Approx.)	Base	Atmosphere B-Vac./C-Gas	Filament Designation	Light Center Length (Inches)	Max. Overall Length (Inches)	Rated Average Lab Life (Hours)	Fig. No.
----------	-------------	---------------------	--------------	----------------------	---------------------------------------	------	-------------------------	----------------------	------------------------------	------------------------------	--------------------------------	----------

T-1 1/4 BULB 7/32" (5.5mm) DIAMETER<sup>(2)</sup> (continued)

1	336	Aircraft	14.0	.08A	50	Midget Grooved	B	C-2F	.38	63	1,500	54
2	386	Indicator	14.0	.08A	30	Midget Grooved	B	C-2F	.38	63	40,000 <sup>(43)(79)</sup>	54
3	382	Indicator	14.0	.08A	30	S.C. Midget Flanged	B	C-2F	.38	63	40,000 <sup>(43)(79)</sup>	50
4	73	Indicator <sup>(133)</sup>	14.0	.08A	30	Wedge	B	C-2F	.40	80	15,000 <sup>(79)</sup>	52
5	73E	Indicator — Extended leads — 5/8"	14.0	.08A	30	Wire Terminal <sup>(122)(129)</sup>	B	C-2F	—	80	15,000 <sup>(79)</sup>	55
6	37	Auto <sup>(133)</sup>	14.0	.09A	50	Wedge	B	C-2F	.40	80	2,500	52
7	2162D	Indicator — Approx. 1" leads	14.0	.10A	50	Wire Terminal <sup>(74)</sup>	B	C-2F	—	52	10,000 <sup>(79)</sup>	49
8	74	Auto	14.0	.10A	70	Wedge	B	C-2F	.40	80	1,000	52
9	70	Auto <sup>(14)(126)</sup>	14.0	.15A	1.50	Wedge	B	C-2F	.40	80	100	52
10	370	Indicator	18.0	.04A	.15	S.C. Midget Flanged	B	C-2F	.38	63	10,000 <sup>(79)</sup>	50
11	1764D	Indicator — Min. 1" leads — White bead	28.0	.04A	.34	Wire Terminal <sup>(74)</sup>	B	C-2F	—	52	4,000 <sup>(79)</sup>	49
12	327	Aircraft	28.0	.04A	.34	S.C. Midget Flanged	B	C-2F	.38	63	4,000 <sup>(79)</sup>	50
13	327	Aircraft — Aged and selected	28.0	.04A	.34	S.C. Midget Flanged	B	C-2F	.38	63	4,000 <sup>(79)</sup>	50
	AS-15	± 15% C.P.	28.0	.04A	—	S.C. Midget Flanged	B	C-2F	.38	63	4,000 <sup>(79)</sup>	50
14	327R	Aircraft — Coated Red	28.0	.04A	—	S.C. Midget Flanged	B	C-2F	.38	63	4,000 <sup>(79)</sup>	50
15	334	Aircraft	28.0	.04A	.34	Midget Grooved	B	C-2F	.38	63	4,000 <sup>(79)</sup>	54
16	7327	Aircraft	28.0	.04A	.34	Bi-Pin M-23	B	C-2F	.50	61	4,000 <sup>(79)</sup>	53
17	7378	Indicator — Pin length non-std.	28.0	.04A	.34	Bi-Pin M-23	B	C-2F	.50	61	4,000 <sup>(79)</sup>	—
18	335	Indicator	28.0	.04A	.34	Midget Screw	B	C-2F	.52	72	4,000 <sup>(79)</sup>	51
19	2187D	Indicator — Min. 1" leads — Pink bead	28.0	.04A	.30	Wire Terminal <sup>(74)</sup>	B	C-2F	—	52	7,000 <sup>(42)(79)</sup>	49
20	387	Indicator	28.0	.04A	.30	S.C. Midget Flanged	B	C-2F	.38	63	7,000 <sup>(42)(79)</sup>	50
21	388	Indicator	28.0	.04A	.30	Midget Grooved	B	C-2F	.38	63	7,000 <sup>(42)(79)</sup>	54
22	7387	Indicator	28.0	.04A	.30	Bi-Pin M-23	B	C-2F	.50	61	7,000 <sup>(42)(79)</sup>	53
23	85	Indicator	28.0	.04A	.30	Wedge	B	C-2F	.40	80	7,000 <sup>(79)</sup>	52
24	385 <sup>(78)</sup>	Indicator	28.0	.04A	.15	S.C. Midget Flanged	B	C-2F	.44 <sup>(147)</sup>	.81	10,000 <sup>(43)(79)</sup>	50

<sup>(14)</sup> This lamp is specially designed for a particular purchaser and may not be suitable for other uses because of its excessive wattage requirements for the bulb size. Consult the nearest GE Lamp Sales Office for application information.

<sup>(42)</sup> Actual life depends upon use and environment. Theoretical design average life is 25,000 hours.

<sup>(43)</sup> Actual life depends upon use and environment. Theoretical design average life is 50,000 hours.

<sup>(74)</sup> This butt seal wire terminal lamp is normally considered a subassembly. The glass-to-metal seal and glass tip are fragile. Therefore, any bending or soldering of the wire terminal closer than 1/8" from the glass should be avoided since the bending or heat can cause leaks in the seal. Solderability may be adversely affected by storage for an extended period in excess of six months or by storage in a high humidity environment. Lamps with tinned leads would not be subject to these storage restrictions.

<sup>(78)</sup> GE Lamp #385 is not interchangeable with other manufacturers' lamp

#385. ANSI specifies .38" light center length and .63" maximum overall length.

<sup>(79)</sup> Life shown is AC voltage only. DC life will be approx. 50% of AC.

<sup>(122)</sup> This is a wire terminal lamp. The glass-to-metal seal (and tip where applicable) are susceptible to damage by thermal shock, and soldering or welding within 1/8" of the glass should be avoided as glass cracks and air leaks may develop. Solderability may be adversely affected by storage for an extended period in excess of six months or by storage in a high humidity environment.

Lamps with tinned leads would not be subject to these storage restrictions. Nickel-plated leads are not recommended for soldering; however, their ability to be welded is not affected by these storage restrictions.

<sup>(126)</sup> Intermittent service only.

<sup>(129)</sup> Leads cleaned and solderable.

<sup>(133)</sup> Satisfactory for use when noise requirements apply.

<sup>(147)</sup> Differs from ANSI.

# Miniature Lamp Specifications

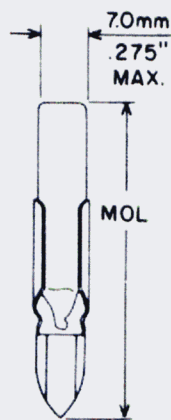

Fig. 58  
T-2

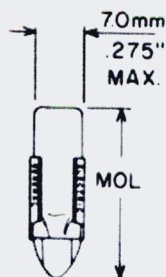

Fig. 59  
T-2  
TEL. SLIDE  
ANSI NO. 5

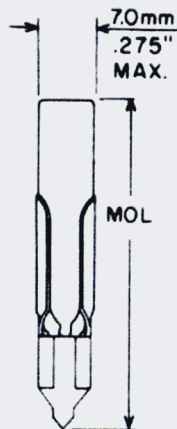

Fig. 60  
T-2

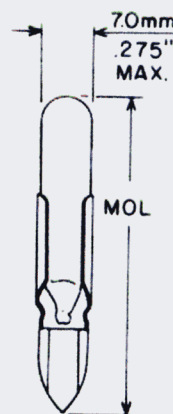

Fig. 61  
T-2

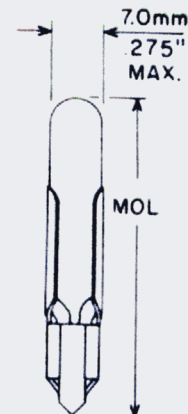

Fig. 62  
T-2

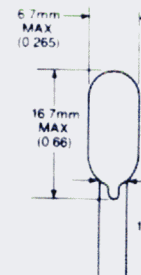

Fig. 99  
T-2

Line No.	GE Lamp No.	Primary Application	Design Volts	Design Amps	Mean Spherical Candle-Power (Approx.)	Base	Design End <sup>(80)</sup> Foot-Candles	Atmosphere B-Vac./C-Gas	Filament Designation	Approx. Avg. Cold Resistance	Max. Overall Length (Inches)	Rated Average Lab Life (Hours)	FIN
----------	-------------	---------------------	--------------	-------------	---------------------------------------	------	---	-------------------------	----------------------	------------------------------	------------------------------	--------------------------------	-----

## T-2 BULB 1/4" (6.3mm) DIAMETER

1	<b>3026</b>	Halogen, Instrument <sup>(11)</sup>	6.3	.13-2W	17.50	Wire Terminal <sup>(61)</sup>	—	C	C-6	—	.66	75 <sup>(116)</sup>	9
2	<b>10C5</b>	Telephone	10.0	.035-.045A	.06	Tel. Slide #5	400	B	C-2V	28	.92	10,000 <sup>(79)</sup>	5
3	<b>12A1</b>	Telephone	12.0	.09-11A	.30	Tel. Slide #1	900	B	C-2F	12	1.69	7,500 <sup>(79)</sup>	5
4	<b>24B1</b>	Telephone	24.0	.035-.045A	.20	Tel. Slide #1	600	B	C-2F	62	1.69	5,000 <sup>(79)</sup>	5
5	<b>24D1</b>	Telephone	24.0	.09-11A	.70	Tel. Slide #1	2,000	B	C-2F	22	1.69	5,000 <sup>(79)</sup>	5
6	<b>24E1</b>	Telephone	24.0	.032-.038A	.20	Tel. Slide #1	450	B	C-2F	70	1.69	5,000 <sup>(79)</sup>	5
7	<b>24F5</b>	Telephone	24.0	.032-.038A	.17	Tel. Slide #5	650	B	C-2F	70	.92	5,000 <sup>(79)</sup>	5
8	<b>24EX</b>	Telephone	24.0	.032-.038A	.20	Tel. Slide #1	350	B	C-2F	70	1.69	5,000 <sup>(79)</sup>	6
9	<b>24X</b>	Spec. Tele. slide base raised prick punches	24.0	.032-.038A	.20	Special #2	350	B	C-2F	70	1.69	5,000 <sup>(79)</sup>	6
10	<b>35A1</b>	Telephone	35.0	.035-.045A	.55	Tel. Slide #1	900	B	C-2F	76	1.69	3,000 <sup>(79)</sup>	5
11	<b>35A2</b>	Telephone	35.0	.035-.045A	.55	Tel. Slide #2	900	B	C-2F	76	1.69	3,000 <sup>(79)</sup>	6
12	<b>48C1</b>	Telephone	48.0	.032-.038A	.40	Tel. Slide #1	750	B	C-2F	140	1.69	5,000 <sup>(79)</sup>	5
13	<b>48C2</b>	Telephone	48.0	.032-.038A	.40	Tel. Slide #2	750	B	C-2F	140	1.69	5,000 <sup>(79)</sup>	6
14	<b>48D1</b>	Telephone	48.0	.017-.025A	.12	Tel. Slide #1	250	B	C-2F	265	1.69	15,000 <sup>(79)</sup>	5
15	<b>48D2</b>	Telephone	48.0	.017-.025A	.12	Tel. Slide #2	250	B	C-2F	265	1.69	15,000 <sup>(79)</sup>	6
16	<b>55C1</b>	Telephone	55.0	.045-.06A	1.10	Tel. Slide #1	2,200	B	C-2F	96	1.69	5,000 <sup>(79)</sup>	5
17	<b>55C2</b>	Telephone	55.0	.045-.06A	1.10	Tel. Slide #2	2,200	B	C-2F	96	1.69	5,000 <sup>(79)</sup>	6
18	<b>60A1</b>	Telephone	60.0	.045-.055A	1.20	Tel. Slide #1	2,200	B	C-2F	102	1.69	5,000 <sup>(79)</sup>	5

## T-2 BULB 1/4" (6.8mm) DIAMETER

19	<b>6PSB</b>	Indicator	6.0	14A	—	Slide #5	550	B	C-2F	—	1.11	20,000	—
20	<b>12PSB</b>	Indicator	12.0	17A	—	Slide #5	2000	B	C-2F	—	1.11	12,000	—
21	<b>18ESB</b>	Indicator	18.0	04A	—	Slide #5	850	B	C-2F	—	1.11	5,000	—
22	<b>24PSB</b>	Indicator	24.0	073A	—	Slide #5	3000	B	C-2F	—	1.11	10,000	—
23	<b>28PSB</b>	Indicator	28.0	04A	—	Slide #5	1600	B	C-2F	—	1.11	5,000	—
24	<b>48ESB</b>	Indicator	48.0	04A	—	Slide #5	3000	B	CC-2F	—	.92	5,000	—
25	<b>48PSB</b>	Indicator	48.0	05A	—	Slide #5	1800	B	C-7A	—	1.11	10,000	—
26	<b>60PSB</b>	Indicator	60.0	05A	—	Slide #5	2200	B	C-7A	—	1.11	7,500	—
27	<b>120PS</b>	Indicator	120.0	025A	—	Wire Terminal	1200	B	CC-7A	—	.98	10,000	—
28	<b>120PSB</b>	Indicator	120.0	025A	—	Slide #5	1200	B	CC-7A	—	1.11	10,000	—

<sup>(11)</sup> CAUTION: This halogen-cycle bulb could shatter if scratched or damaged. Use appropriate protection when handling, using, or disposing. Use in fixtures designed for the high temperature required for proper operation and that offer protection in case the bulb shatters. Turn power off when changing lamp. Allow lamp to cool before removal. For satisfactory performance: (1) limit seal and outer lead wire temperature to 350°C or lead wire deterioration may occur; (2) maintain a minimum bulb wall temperature of 250°C for operation of the halogen cycle; (3) operate at design volts; (4) if

further processing of the leads, such as bending, welding, crimping, etc. is required, care must be taken to assure that the lamp seal area is not strained, cracked, chipped, or otherwise damaged or premature lamp failure may occur.

<sup>(61)</sup> Consult nearest GE Lamp Sales Office for application information.

<sup>(79)</sup> Life shown is AC voltage only. DC life will be approx. 50% of AC.

<sup>(80)</sup> E.F.C. values will vary depending upon type of equipment used for measurement.

<sup>(116)</sup> Life tests are performed on DC voltage only.



# Miniature Lamp Specifications

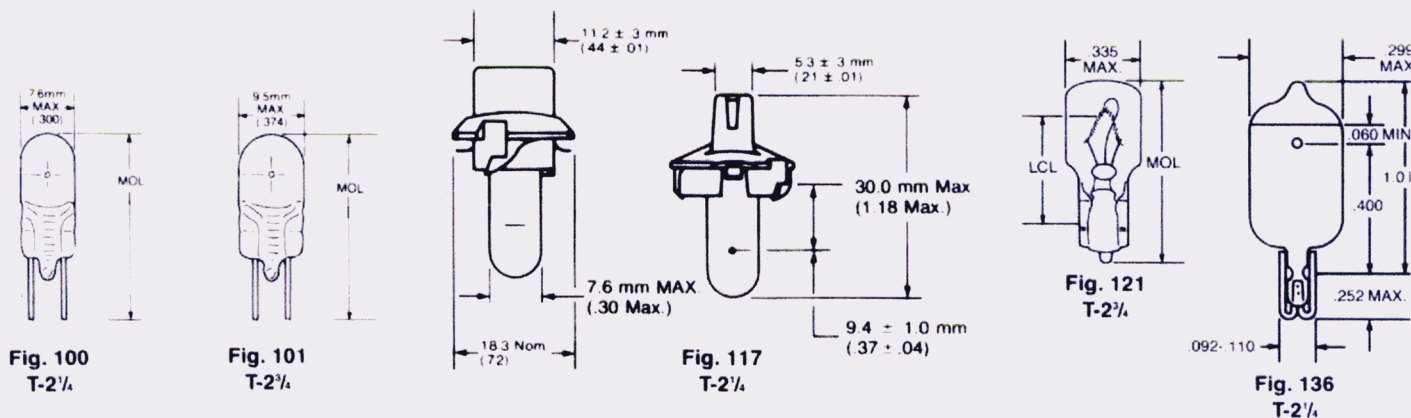

Line No.	GE Lamp No.	Primary Application	Design Volts	Design Watts or Amps	Mean Spherical Candle-Power (Approx.)	Base	Atmosphere B-Vac./C-Gas	Filament Designation	Light Center Length (Inches)	Max. Overall Length (Inches)	Rated Average Lab Life (Hours)	Fig. No.
----------	-------------	---------------------	--------------	----------------------	---------------------------------------	------	-------------------------	----------------------	------------------------------	------------------------------	--------------------------------	----------

## T-2 1/4 BULB 9/32" (7.5mm) DIAMETER

1	<b>777</b>	Flashlight, Halogen <sup>(131)</sup>	4.0	1.20A	5.5	G-4 Two Pin <sup>(124)</sup>	C	C-6	.77	1.0	275	100
2	<b>784</b>	Emergency Lighting — Halogen <sup>(131)</sup>	6.0	1.00A	9.0	G-4 Two Pin <sup>(124)</sup>	C	C-6	.77	1.0	50	100
3	<b>785</b>	Emergency Lighting — Halogen <sup>(131)</sup>	6.0	1.33A	13.0	G-4 Two Pin <sup>(124)</sup>	C	C-6	.77	1.0	50	100
4	<b>787</b>	Instrument — Halogen <sup>(131)</sup>	6.0	1.67A	16.0	G-4 Two Pin <sup>(124)</sup>	C	C-6	.77	1.0	100	100
5	<b>767</b>	Instrument — Halogen <sup>(131)</sup>	6.0	2.00A	19.0	Miniature Bayonet	C	C-6	.56	1.13	50 <sup>(75)</sup>	—
6	<b>786</b>	Emergency Lighting — Halogen <sup>(131)</sup>	6.0	2.00A	19.0	G-4 Two Pin <sup>(124)</sup>	C	C-6	.77	1.0	50	100
7	<b>788</b>	Instrument — Halogen <sup>(131)</sup>	6.0	3.33A	32.0	G-4 Two Pin <sup>(124)</sup>	C	C-6	.77	1.0	100	100
8	<b>774</b>	Emergency Lighting — Halogen <sup>(131)</sup>	12.0	.67A	13.0	G-4 Two Pin <sup>(124)</sup>	C	C-6	.77	1.0	50	100
9	<b>783</b>	Emergency Lighting — Halogen <sup>(131)</sup>	12.0	1.00A	22.0	G-4 Two Pin <sup>(124)</sup>	C	C-6	.77	1.0	50	100
10	<b>882</b>	Auto Inst. — Halogen <sup>(131)(150)</sup>	12.8	.35A	3.8	Printed Circuit Socket	C	C-6	.37	1.18	2000	117
11	<b>882-X</b>	Auto Inst. — Halogen <sup>(131)(150)</sup>	12.8	.35A	3.8	G-4 Two Pin <sup>(124)</sup>	C	C-6	.77	1.0	2000	100
12	<b>891</b>	Auto High Mounted Stop, Halogen <sup>(131)(156)</sup>	12.8	.63A	11.0	G-4 Two Pin <sup>(124)</sup>	C	C-6	.77	1.0	500	100
13	<b>2040</b>	Auto Light Bar — Halogen <sup>(156)</sup>	12.8	.625A	10.5	Wedge	C	C-6	.4	1.25	500	136

## T-2 1/2 BULB 5/16" (8.3mm) DIAMETER

14	<b>28MB</b>	Indicator	28.0	.04A	29	Miniature Bayonet	B	C-2F	—	1.19	5,000	—
15	<b>60MB</b>	Indicator	60.0	.05A	73	Miniature Bayonet	B	C-7A	—	1.19	7,500	—
16	<b>120MB</b>	Indicator	120.0	.025A	.36	Miniature Bayonet	B	CC-7A	—	1.19	10,000	—

## T-2 3/4 BULB 11/32" (8.7mm) DIAMETER

17	<b>778</b>	Instrument — Halogen — High temp. fixtures <sup>(131)</sup>	6.0	3.33A	32.0	G-4 Two Pin <sup>(124)</sup>	C	C-6	.77	1.05	100	101
18	<b>794</b>	Special Service — Halogen <sup>(131)</sup>	10.5	1.50A	15.0	G-4 Two Pin <sup>(124)</sup>	C	C-6	.77	1.05	5,000	101
19	<b>773</b>	Special Service — Halogen <sup>(131)</sup>	12.0	.67A	10.0	G-4 Two Pin <sup>(124)</sup>	C	C-6	.77	1.05	1,000 <sup>(75)</sup>	101
20	<b>789</b>	Instrument — Halogen <sup>(131)</sup>	12.0	1.17A	22.0	G-4 Two Pin <sup>(124)</sup>	C	C-6	.77	1.05	200	101
21	<b>780</b>	Strip Light — Halogen <sup>(131)</sup>	12.0	10W	12.0	G-4 Two Pin <sup>(124)</sup>	C	C-6	.77	1.05	2,000	101
22	<b>782</b>	Special Service — Halogen <sup>(131)</sup>	12.0	1.66A	25.0	G-4 Two Pin <sup>(124)</sup>	C	C-6	.77	1.05	2,000	101
23	<b>24</b>	Auto Side Marker	14.0	.24A	2.0	Wedge	B	C-2V	.46	.91	1,500	121
24	<b>24NA</b>	Auto Side Marker	14.0	.24A	1.5	Wedge	B	C-2V	.46	.91	1,500	121
25	<b>790</b>	Instrument — Halogen <sup>(131)</sup>	14.0	1.79A	42.0	G-4 Two Pin <sup>(124)</sup>	C	C-6	.77	1.05	200	101
26	<b>791</b>	Instrument — Halogen <sup>(131)</sup>	14.0	2.50A	61.0	G-4 Two Pin <sup>(124)</sup>	C	C-6	.77	1.05	200	101

<sup>(75)</sup> Estimated. Based on limited test information.

<sup>(124)</sup> .028" metal pins spaced 4 mm (.157") apart. GE's all-glass two-pin lamps might not be compatible with all G-4 sockets since many sockets do not provide clearance for the exhaust tip.

<sup>(131)</sup> **CAUTION:** This halogen-cycle lamp is pressurized and may shatter. Do not operate lamp in excess of rated voltage as this will increase lamp pressure and the risk of shattering. Protect lamp against abrasions and scratches and against liquids when lamp is operating.

To guard against personal injury, wear protective eyeglasses and clothing when handling lamp. Provide protective screen or shield with equipment in which lamp is installed or used. Turn power off when installing and before removing lamp. Dispose of lamp with care.

Because of heat generated by lamp, use only with sockets and

tures. Do not operate in proximity to substances or materials that are flammable or adversely affected by heat or drying. Allow lamp to cool before removing.

If further processing of the leads, such as bending, welding, crimping, etc., is required, care must be taken to assure that the lamp seal area is not strained, cracked, chipped, or otherwise damaged, or premature lamp failure may occur. For satisfactory performance: (1) limit seal and outer lead wire temperature to 350°C or lead wire deterioration may occur; (2) maintain a minimum bulb wall temperature of 250°C for operation of the halogen cycle; (3) operate at design volts.

<sup>(150)</sup> **CAUTION:** This halogen cycle bulb is pressurized. It may shatter if glass is cracked or scratched. Never operate outside of instrument panel or when panel cover is removed.

<sup>(156)</sup> **CAUTION:** This halogen cycle inner bulb is pressurized. It may

# Miniature Lamp Specifications

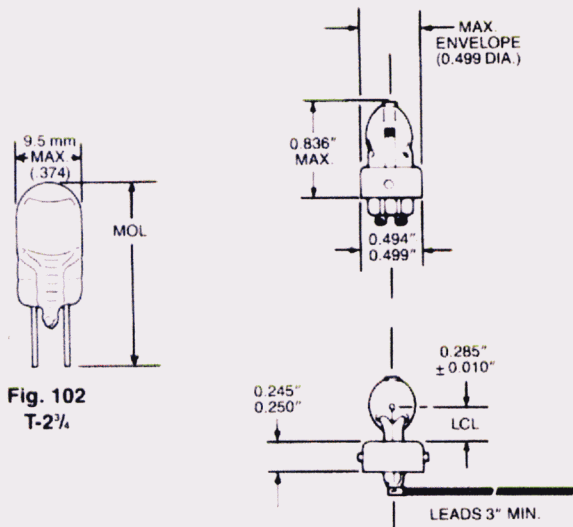

Fig. 102  
T-2<sup>3/4</sup>

Fig. 106  
T-3

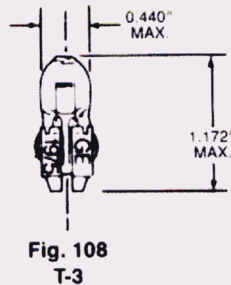

Fig. 108  
T-3

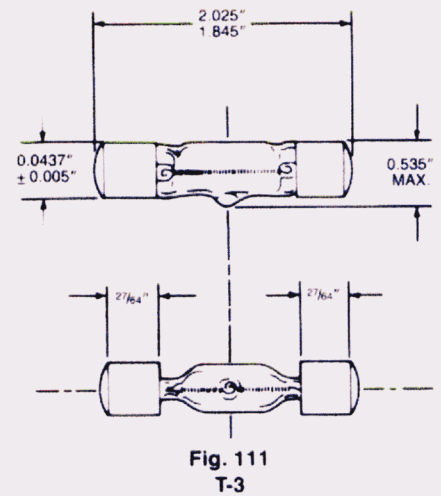

Fig. 111  
T-3

Line No.	GE Lamp No.	Primary Application	Design Volts	Design Watts or Amps	Mean Spherical Candle-Power (Approx.)	Base	Atmosphere B-Vac./C-Gas	Filament Designation	Light Center Length (Inches)	Max. Overall Length (Inches)	Rated Average Lab Life (Hours)	Fig. No.
TL-2 <sup>3/4</sup> BULB 11/32" (8.7mm) DIAMETER												
1	2604X	Instrument — Halogen, Lens end <sup>(131)</sup>	5.0	2.00A	-(128)	G-4 Two Pin <sup>(124)</sup>	C	C-6	—	1.18	5,000	102
2	2605	Instrument — Halogen, Lens end <sup>(131)</sup>	6.0	1.67A	-(141)	G-4 Two Pin <sup>(124)</sup>	C	C-6	—	1.18	100	102
T-3 BULB 3/8" (9.5mm) DIAMETER												
3	1974	Instrument — Quartz Bulb — 3" bare leads horizontal — Halogen <sup>(114)</sup>	6.0	20W	10	Wire Terminal	C	C-6	28	1.14	10,000+	106
4	1392	Instrument — Quartz Bulb — Halogen <sup>(114)</sup>	6.0	20W	10	Two Pin on Reflector	C	C-6	—	1.74	10,000	—
5	1977	Special Service — Quartz Bulb — Halogen <sup>(114)</sup>	8.5	62W	110	Double Slide	C	C-6	44	1.14	50	108
6	1962	Special Service — Quartz Bulb — 3" bare leads horizontal — Halogen <sup>(114)</sup>	8.5	62W	110	Wire Terminal	C	C-6	28	1.14	50	106
7	1962B	Special Service — Quartz Bulb — 9" insulated leads horizontal — Halogen <sup>(114)</sup>	8.5	62W	110	Wire Terminal	C	C-6	28	1.14	50	106
8	1962DZ	Special Service — Quartz Bulb — 12" insulated leads down — Halogen <sup>(114)</sup>	8.5	62W	80	Wire Terminal	C	C-6	28	1.20	150	106
9	1962DX	Special Service — Quartz Bulb — 4" bare leads down — Halogen <sup>(114)</sup>	8.5	62W	80	Wire Terminal	C	C-6	29	1.14	150	106
10	1962TY	Medical — Quartz Bulb — 4" Leads Horizontal — Halogen <sup>(114)</sup>	8.5	62W	110	Wire Terminal	C	C-6	29	—	50	106
11	1962BG	Aircraft <sup>(114)</sup>	8.5	62W	110	Wire Terminal Down	C	C-6	28	—	50	—
12	1978X	Aircraft Navigation — Quartz Bulb — Halogen <sup>(114)</sup>	10.0	100W	130	Special	C	C-8	—	2.15	2,000	111
13	1988	Aircraft Navigation — Quartz Bulb — Halogen <sup>(114)</sup>	10.0	100W	130	Special, Wire Leads	C	C-8	—	2.15	2,000	—
14	1975	Aircraft Gunsight — Quartz Bulb — Halogen <sup>(114)</sup>	12.8	25W	25	Double Slide	C	C-6	44 <sup>(147)</sup>	1.17	500	108
15	2075	Aircraft <sup>(114)</sup>	12.8	1.95A	25	Double Slide	C	C-6	—	1.17	500	108

<sup>(114)</sup> CAUTION: This halogen-cycle bulb could shatter if scratched or damaged. Use appropriate protection for eyes and exposed skin when handling, using or disposing. Use in fixtures designed for the high temperature required for proper operation and that offer protection in case the bulb shatters. Turn power off when changing lamps. Allow lamp to cool before removal. For satisfactory performance: (1) limit seal and outer lead wire temperature to 350°C or lead wire deterioration may occur; (2) maintain a minimum bulb wall temperature of 250°C for operation of the halogen cycle; (3) remove grease or fingerprints from bulb by cleaning with a grease-free solvent; (4) operate at design volts.

<sup>(128)</sup> Minimum 1/8" spot at .100" from bulb top.

<sup>(131)</sup> CAUTION: This halogen-cycle lamp is pressurized and may shatter. Do not operate lamp in excess of rated voltage as this will increase lamp pressure and the risk of shattering. Protect lamp against abrasions and scratches and against liquids when lamp is operating.

with equipment in which lamp is installed or used. Turn power off when installing and before removing lamp. Dispose of lamp with care.

Because of heat generated by lamp, use only with sockets and housing designed to withstand the lamp's high operating temperatures. Do not operate in proximity to substances or materials that are flammable or adversely affected by heat or drying. Allow lamp to cool before removing.

If further processing of the leads, such as bending, welding, crimping, etc., is required, care must be taken to assure that the lamp seal area is not strained, cracked, chipped, or otherwise damaged or premature lamp failure may occur. For satisfactory performance: (1) limit seal and outer lead wire temperature to 350°C or lead wire deterioration may occur; (2) maintain a minimum bulb wall temperature of 250°C for operation of the halogen cycle; (3) operate at design volts.

<sup>(147)</sup> At 10 mm from bulb end, beam must cover an 8 mm diameter circle



# Miniature Lamp Specifications

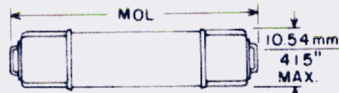

Fig. 70  
T-3

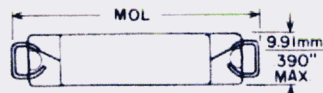

Fig. 71  
T-3

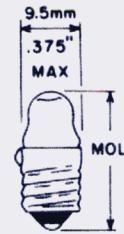

Fig. 74  
TL-3

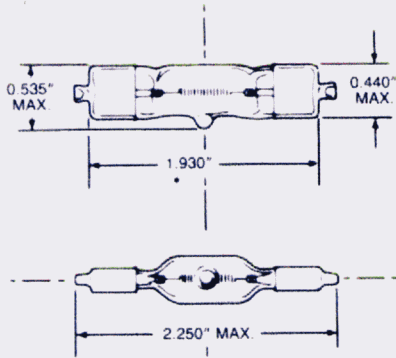

Fig. 107  
T-3

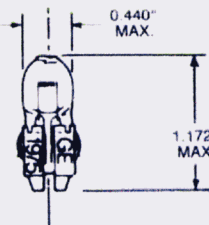

Fig. 108  
T-3

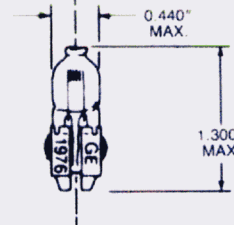

Fig. 110  
T-3

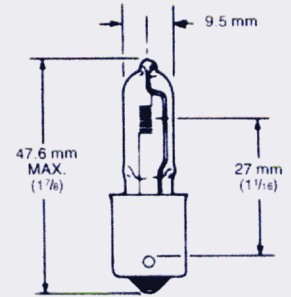

Fig. 114  
T-3

Line No.	GE Lamp No.	Primary Application	Design Volts	Design Watts or Amps	Mean Spherical Candle-Power (Approx.)	Base	Atmosphere B-Vac./C-Gas	Filament Designation	Light Center Length (Inches)	Max. Overall Length (Inches)	Rated Average Lab Life (Hours)	Fig. No.
----------	-------------	---------------------	--------------	----------------------	---------------------------------------	------	-------------------------	----------------------	------------------------------	------------------------------	--------------------------------	----------

## T-3 BULB 3/8" (9.5mm) DIAMETER (continued)

1	211-2	Auto	12.8	97A	12	Miniature Cap	C	C-8	—	1.72	1,000	70
2	561	Auto	12.8	97A	12	Rigid Loop	C	C-8	—	1.72	1,000	71
3	1976	Aircraft — Quartz Bulb — Halogen <sup>(114)</sup>	13.0	75W	115	Double Slide	C	C-6	.56	1.3	400	110
4	563	Auto	13.5	52A	4	Rigid Loop	C	C-8	—	1.72	1,000 <sup>(4)</sup>	71
5	214-2	Auto	13.5	52A	4	Miniature Cap	C	C-8	—	1.72	1,000 <sup>(4)</sup>	70
6	212-2	Auto	13.5	.74A	6	Miniature Cap	C	C-8	—	1.72	2,000 <sup>(4)</sup>	70
7	562	Auto	13.5	.74A	6	Rigid Loop	C	C-8	—	1.72	2,000 <sup>(4)</sup>	71
8	1982	Aircraft Navigation — Quartz Bulb — Halogen <sup>(114)</sup>	28.0	75W	110	S.C. Bayonet	C	CC-8 <sup>(13)</sup>	1.06	1.88	1,000	114
9	1968	Aircraft Gunsight — Quartz Bulb — Halogen <sup>(114)</sup>	28.0	25W	15	Double Slide	C	C-2V <sup>(13)</sup>	41	1.17	500	108
10	1967	Aircraft — Quartz Bulb — Halogen <sup>(114)</sup>	28.0	150W	210	Special Sleeve	C	CC-8 <sup>(13)</sup>	—	2.25	1,000	107
11	1964	Aircraft — Quartz Bulb — Halogen <sup>(114)</sup>	28.0	150W	230	Special Sleeve	C	CC-8	—	2.25	1,000	107
12	1970	Aircraft — Quartz Bulb — Halogen <sup>(114)</sup>	28.0	100W	150	Special Sleeve	C	CC-8	—	2.25	1,000	107
13	1970X	Aircraft — Quartz Bulb — Halogen <sup>(114)</sup>	28.0	100W	140	Special Sleeve	C	CC-8 <sup>(13)</sup>	—	2.25	1,000 <sup>(75)</sup>	107
14	1956	Aircraft <sup>(74)(114)</sup>	28.0	200W	525	Wire Terminal	C	CC-6	.87	1.46	50	—
15	1946	Aircraft <sup>(74)(114)</sup>	28.0	250W	660	Wire Terminal	C	CC-6	.87	1.46	50	—

## TL-3 BULB 3/8" (9.5mm) DIAMETER

16	112	Flashlight — 1AA, C or D cell	1.2	.22A	—	Miniature Screw	B	S-2	—	.93	5 <sup>(116)</sup>	74
17	222	Flashlight — AA cells	2.25	.25A	—	Miniature Screw	B	C-2R	—	.93	5 <sup>(116)</sup>	74
18	2121D	Indicator — Approx. 3/8" leads — down position <sup>(74)</sup>	2.25	.25A	—	Wire Terminal	B	C-2R	—	.82	5 <sup>(116)</sup>	—
19	243	Flashlight — 2C cells	2.33	.27A	—	Miniature Screw	B	C-2R	—	.93	10 <sup>(116)</sup>	74

<sup>(4)</sup> At 14 volts.

<sup>(13)</sup> Supported.

<sup>(74)</sup> This butt seal wire terminal lamp is normally considered a subassembly. The glass-to-metal seal and glass tip are fragile. Therefore, any bending or soldering of the wire terminal closer than 1/8" from the glass should be avoided since the bending or heat can cause leaks in the seal. Solderability may be adversely affected by storage for an extended period in excess of six months or by storage in a high humidity environment. Lamps with tinned leads would not be subject to these storage restrictions.

<sup>(114)</sup> CAUTION: This halogen-cycle bulb could shatter if scratched or damaged. Use appropriate protection for eyes and exposed skin when handling, using or disposing. Use in fixtures designed for the high temperature required for proper operation and that offer protection in case the bulb shatters. Turn power off when changing lamps. Allow lamp to cool before removal. For satisfactory performance: (1) limit seal and outer lead wire temperature to 350°C or lead wire deterioration may occur; (2) maintain a minimum bulb wall temperature of 250°C for operation of the halogen cycle; (3) remove grease or fingerprints from bulb by cleaning with a

# Miniature Lamp Specifications

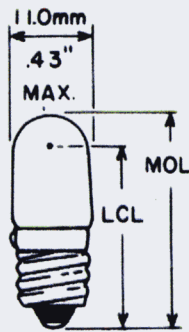

Fig. 75  
T-3/4

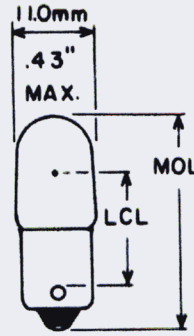

Fig. 76  
T-3/4

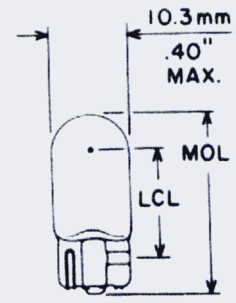

Fig. 77  
T-3/4

Line No.	GE Lamp No.	Primary Application	Design Volts	Design Watts or Amps	Mean Spherical Candle-Power (Approx.)	Base	Atmosphere B-Vac./C-Gas	Filament Designation	Light Center Length (Inches)	Max. Overall Length (Inches)	Rated Average Lab Life (Hours)	Fig. No.
T-3/4 BULB <sup>13</sup> / <sub>32</sub> " (10mm) DIAMETER												
1	1846	Special Service — Resistance Ballast	.8	.033A	—	Miniature Screw	B	C-2R	—	1.19	—	75
2	49	Radio	2.0	.06A	.04	Miniature Bayonet	B	S-2	—	1.19	1,000	76
3	127	Toy, Indicator	2.47	.275A	.48	Wedge	B	C-2R	.65	1.06	30	77
4	43	Indicator	2.5	.50A	.50	Miniature Bayonet	B	C-2R	.78	1.19	3,000	76
5	1490	Radio	3.2	.16A	.20	Miniature Bayonet	B	C-2R	.78	1.19	3,000	76
6	1906	Signal	5.0	.07A	.19	Miniature Bayonet	B	C-6	.62	1.19	1,000	76
7	285	Signal	5.0	.09A	.25	Wedge	B	C-2R	.56	1.06	1,500 <sup>(116)</sup>	77
8	1850	Signal — Plane of filament perpendicular to base pins	5.0	.09A	.25	Miniature Bayonet	B	C-2R	.62	1.19	1,500 <sup>(116)</sup>	76
9	1850W	Signal — Random base pin orientation	5.0	.09A	.25	Miniature Bayonet	B	C-2R	.62	1.19	1,500 <sup>(116)</sup>	76
10	316	Aircraft <sup>(144)</sup>	6.0	.70A	3.40	Miniature Bayonet	C	C-2R	.62	1.19	500	76
11	149	Emergency Lighting	6.15	.53A	3.50	Wedge	B	C-2R	.56	1.06	15	77
12	1302	Radio	6.3	.04A	.08	Miniature Bayonet	B	C-6	.75	1.19	5,000	76
13	755	Indicator	6.3	.15A	.33	Miniature Bayonet	B	C-2R	.78	1.19	20,000 <sup>(43)</sup>	76
14	267	Indicator — Flasher Lamp <sup>(70)</sup>	6.3	.15A	.33	Miniature Bayonet	B	C-2R	.62	1.19	5,000 <sup>(3)</sup>	76
15	159	Radio, TV and Indicator	6.3	.15A	.34	Wedge	B	C-2R	.50	1.06	5,000 <sup>(44)</sup>	77
16	1847	Radio, TV and Indicator	6.3	.15A	.38	Miniature Bayonet	B	C-2R	.78	1.19	5,000 <sup>(44)</sup>	76
17	40	Radio and Indicator	6.3	.15A	.52	Miniature Screw	B	C-2R	.97	1.19	3,000	75
18	47	Radio, TV, and Indicator	6.3	.15A	.52	Miniature Bayonet	B	C-2R	.78	1.19	3,000	76
19	447	Indicator and Coin Machine	6.3	.15A	.52	Wedge	B	C-2V <sup>(13)</sup>	.56	1.06	1,500	77
20	1866	Radio	6.3	.25A	.65	Miniature Bayonet	B	C-2R	.78	1.19	5,000 <sup>(44)</sup>	76
21	259	Radio, TV, and Indicator	6.3	.25A	.65	Wedge	B	C-2R	.65 <sup>(147)</sup>	1.06	5,000 <sup>(44)</sup>	77
22	555	Coin, Novelty	6.3	.25A	.90	Wedge	B	C-2R	.65	1.06	3,000	77
23	44	Indicator, Radio, and TV	6.3	.25A	.90	Miniature Bayonet	B	C-2R	.78	1.19	3,000	76
24	1810	Special Service	6.3	.40A	1.50	Miniature Bayonet	B	C-2R	.72	1.19	3,000	76
25	238	Indicator <sup>(62)(144)</sup>	6.3	.50A	2.00	Miniature Bayonet	C	C-2R	.72	1.19	2,000	76
26	147	Indicator	7.0	.43A	2.00	Wedge	B	C-2R	.56	1.06	1,500	77
27	148	Special Service <sup>(14)</sup>	7.0	.90A	2.00	Wedge	B	C-2V	.56	1.06	200	77
28	947	Signal <sup>(144)</sup>	9.84	.50A	4.00	Miniature Bayonet	C	C-2R	.50	1.19	500	76
29	280	Signal	10.0	.13A	.85	Wedge	B	C-2V	.56	1.06	250	77

<sup>(3)</sup> Useful hours.

<sup>(13)</sup> Supported.

<sup>(14)</sup> This lamp is specially designed for a particular purchaser and may not be suitable for other uses because of its excessive wattage requirements for the bulb size. Consult the nearest GE Lamp Sales Office for application information.

<sup>(43)</sup> Actual life depends upon use and environment. Theoretical design average life is 50,000 hours.

<sup>(44)</sup> At 6.6 volts.

<sup>(62)</sup> Tolerance for light center length  $\pm \frac{1}{32}$ " and axial alignment  $\pm .050$ ".

<sup>(70)</sup> These lamps produce a random flashing indication only. While the majority should flash between 40-160 flashes per minute at normal room temperature, some will be outside this range. As ambient temperature and/or input voltage changes, the flash rate may vary considerably. At rated voltage and room temperature most lamps will flash within 60 seconds.

<sup>(116)</sup> Life tests are performed on DC voltage only.

<sup>(144)</sup> Potentially limited availability in large quantities at certain times of the year. Contact your GE Lamp Representative for current availability information.

<sup>(147)</sup> Differs from ANSI.



# Miniature Lamp Specifications

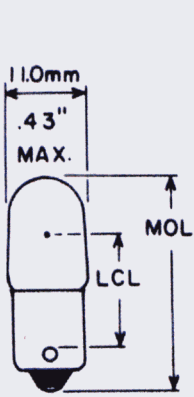

Fig. 76  
T-3/4

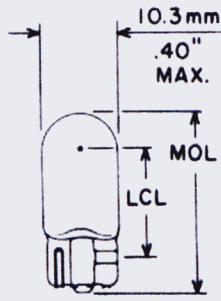

Fig. 77  
T-3/4

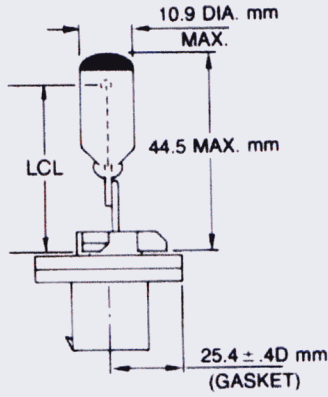

Fig. 115  
T-3/4

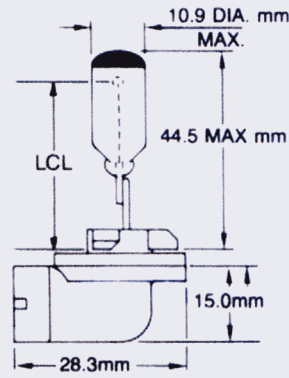

Fig. 116  
T-3/4

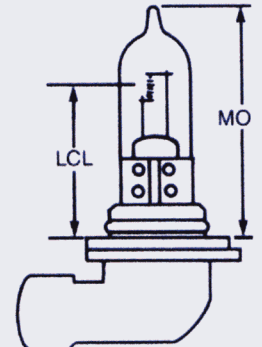

Fig. 122  
T-3/4

Line No.	GE Lamp No.	Primary Application	Design Volts	Design Watts or Amps	Mean Spherical Candle-Power (Approx.)	Base	Atmosphere B-Vac./C-Gas	Filament Designation	Light Center Length (Inches)	Max. Overall Length (Inches)	Rated Average Lab Life (Hours)	Fig. No.
----------	-------------	---------------------	--------------	----------------------	---------------------------------------	------	-------------------------	----------------------	------------------------------	------------------------------	--------------------------------	----------

## T-3/4 BULB <sup>13</sup>/<sub>32</sub>" (10mm) DIAMETER (continued)

1	1408	Signal	10.0	.13A	.85	Miniature Bayonet	B	C-2V <sup>(13)</sup>	.62	1.19	250	76
2	892	Auto, Signal — Halogen <sup>(131)(156)(160)</sup>	12.8	1.25A	28	Axial, Plastic	C	C-6	1.00	2.68	300	115
3	884	Special Service, Halogen <sup>(131)(156)(160)</sup>	12.8	2.10A	43	Axial, Plastic	C	C-6	1.25	2.68	300	115
4	890	Auto — Signal, Halogen <sup>(131)(156)(160)</sup>	12.8	2.10A	43	Axial, Plastic	C	C-6	1.00	2.68	300	115
5	889	Auto — Signal, Halogen <sup>(131)(156)(160)</sup>	12.8	2.10A	43	Right Angle, Plastic	C	C-6	1.00	2.68	300	116
6	885	Auto-Fog Special Service, Halogen <sup>(131)(156)(160)</sup>	12.8	3.90A	100	Axial, Plastic, Prefocus	C	C-6	1.25	2.68	200 <sup>(4)</sup>	115
7	880	Auto-Fog <sup>(17)</sup> — Halogen <sup>(131)(156)(160)</sup> Shielded filament	12.8	2.10A	43	Axial Plastic Prefocus	C	C-6	1.25	2.68	300	115
8	881	Auto-Fog <sup>(17)</sup> — Halogen <sup>(131)(156)(160)</sup> Shielded filament	12.8	2.10A	43	Right Angle Plastic Prefocus	C	C-6	1.25	2.68	300	116
9	893	Auto Fog <sup>(17)(131)(156)</sup>	12.8	2.93A	75	Axial Plastic Prefocus	C	C-6	1.25	2.68	200 <sup>(4)</sup>	115
10	894	Tractor <sup>(17)(131)(156)</sup>	12.8	2.93A	75	Right Angle, Plastic	C	C-6	1.25	2.68	200 <sup>(4)</sup>	116
11	896	Auto Fog <sup>(131)(156)</sup>	12.8	2.93A	75	Right Angle, Plastic	C	C-6	1.25	2.68	200 <sup>(4)</sup>	116
12	886	Auto Fog <sup>(131)(156)</sup>	12.8	3.90A	100	Right Angle, Plastic, Prefocus	C	C-6	1.25	2.68	200 <sup>(4)</sup>	116
13	9006	Auto Headlamp, Replaceable Bulb, Low Beam <sup>(131)(155)</sup>	12.8	55W	80	Right Angle, Plastic, Prefocus	C	C-8	1.240	—	320 <sup>(4)</sup>	122
14	9005	Auto Headlamp, Replaceable Bulb, High Beam <sup>(131)(155)</sup>	12.8	65W	135	Right Angle, Plastic, Prefocus	C	C-8	1.240	—	150 <sup>(4)</sup>	122
15	1816	Aircraft and Auto	13.0	.33A	3	Miniature Bayonet	B	C-2V <sup>(13)</sup>	.62	1.19	1,000	76
16	558	Auto and Indicator Lens end <sup>(68)</sup>	13.0	.33A	—	Wedge	B	C-2V <sup>(13)</sup>	—	1.06	500	—
17	192	Auto Instrument and Indicator	13.0	.33A	3	Wedge	B	C-2V <sup>(13)</sup>	.56	1.06	1,000	77
18	756	Indicator	14.0	.08A	31	Miniature Bayonet	B	C-2F	.62	1.19	15,000 <sup>(43)</sup>	76
19	658	Indicator	14.0	.08A	31	Wedge	B	C-2F	.56	1.06	15,000 <sup>(43)</sup>	77
20	161	Auto, Inst. & Ind. H.D.	14.0	.19A	1	Wedge	B	C-2F	.56	1.06	4,000	77

(4) At 14 volts.

(13) Supported.

(17) Filament shielded.

(43) Actual life depends upon use and environment. Theoretical design average life is 50,000 hours.

(68) Uses lens-end TL-3/4 bulb. Provides 7,000 to 11,000 foot-candles in a 1/4" diameter spot at 1/8" from end of bulb.

(131) CAUTION: This halogen-cycle lamp is pressurized and may shatter. Do not operate lamp in excess of rated voltage as this will increase lamp pressure and the risk of shattering. Protect lamp against abrasions and scratches and against liquids when lamp is operating.

To guard against personal injury, wear protective eyeglasses and clothing when handling lamp. Provide protective screen or shield with equipment in which lamp is installed or used. Turn power off when installing and before removing lamp. Dispose of lamp with care.

Because of heat generated by lamp, use only with sockets and housing designed to withstand the lamp's high operating temperatures. Do not operate in proximity to substances or materials that

are flammable or adversely affected by heat or drying. Allow lamp to cool before removing.

If further processing of the leads, such as bending, welding, crimping, etc., is required, care must be taken to assure that the lamp seal area is not strained, cracked, chipped, or otherwise damaged, or premature lamp failure may occur. For satisfactory performance: (1) limit seal and outer lead wire temperature to 350°C or lead wire deterioration may occur; (2) maintain a minimum bulb wall temperature of 250°C for operation of the halogen cycle; (3) operate at design volts.

(155) CAUTION: This halogen bulb contains gas under pressure and could shatter (with resultant flying fragments). Protect bulb against abrasion or scratches and against liquids when lit. Turn on the bulb only when installed in a headlamp. Replace headlamp if damaged or cracked. Keep bulb out of reach of children and dispose of used bulb with care.

(156) CAUTION: This halogen cycle inner bulb is pressurized. It may shatter if glass is cracked or scratched, or if moisture or liquids hit hot bulb. Never operate bulb outside of housing.

(160) Filament will generate 43 mscp in a non shielded bulb.

# Miniature Lamp Specifications

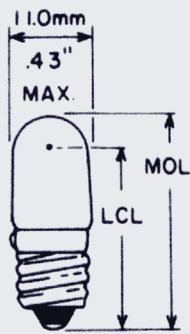

Fig. 75  
T-3/4

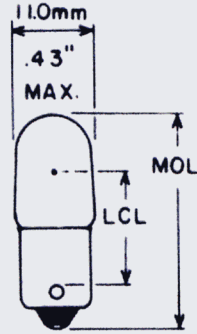

Fig. 76  
T-3/4

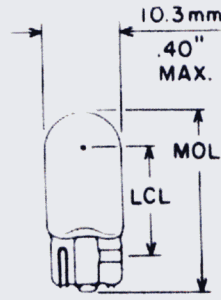

Fig. 77  
T-3/4

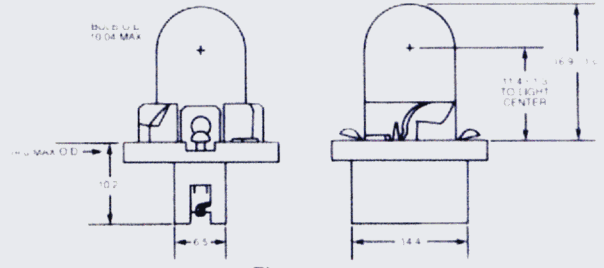

Fig. 120  
T-3/4

(For standard 1/8" hole on P.C. Board)

Line No.	GE Lamp No.	Primary Application	Design Volts	Design Watts or Amps	Mean Spherical Candle-Power (Approx.)	Base	Atmosphere B-Vac./C-Gas	Filament Designation	Light Center Length (Inches)	Max. Overall Length (Inches)	Rated Average Lab Life (Hours)	Fi N
T-3/4 BULB 13/32" (10mm) DIAMETER (continued)												
1	PC-161	Auto, Inst. & Ind. H.D.	14.0	.19A	1	Printed Circuit Socket	B	C-2F	.45	1.11	4,000	12
2	PC161B	Auto Inst. Blue-green	14.0	.19A	—	Printed Circuit Socket	B	C-2F	.45	1.11	4,000	12
3	PC161B2	Auto Inst. Blue	14.0	.19A	—	Printed Circuit Socket	B	C-2F	.45	1.11	4,000	12
4	1487	Indicator	14.0	.20A	1.4	Miniature Screw	B	C-2F	.94	1.19	3,000	—
5	1815	Indicator	14.0	.20A	1.4	Miniature Bayonet	B	C-2F <sup>(147)</sup>	.75	1.19	3,000	—
6	1891	Auto, Radio and Indicator	14.0	.24A	2	Miniature Bayonet	B	C-2F	.62	1.19	500	—
7	158	Auto, Instrument, and Indicator	14.0	.24A	2	Wedge	B	C-2V <sup>(13)</sup>	.56	1.06	500	—
8	PC158	Auto Instrument	14.0	.27A	1.5	Printed Circuit Socket	B	C-2V <sup>(13)</sup>	.56	1.11	500	12
9	124	Auto Vanity	14.0	.27A	1.5	Wedge	B	C-2F	.56	1.06	5,000+	—
10	194	Auto, Inst. & Ind., H.D.	14.0	.27A	2	Wedge	B	C-2F	.56	1.06	2,500	—
11	PC-194	Auto, Inst. & Ind., H.D.	14.0	.27A	2	Printed Circuit Socket	B	C-2F	.45	1.11	2,500	12
12	PC194B	Auto Inst. Blue	14.0	.27A	—	Printed Circuit Socket	B	C-2F	.45	1.11	2,500	12
13	PC194G	Auto Inst. Green	14.0	.27A	—	Printed Circuit Socket	B	C-2F	.45	1.11	2,500	12
14	PC194R	Auto Inst. Red	14.0	.27A	—	Printed Circuit Socket	B	C-2F	.45	1.11	2,500	12
15	PC194B3	Auto Inst. White blue	14.0	.27A	—	Printed Circuit Socket	B	C-2F	.45	1.11	2,500	12
16	194NA	Auto Side marker — Natural Amber bulb — Heavy Duty	14.0	.27A	1.5	Wedge	B	C-2F	—	1.06	2,500	—
17	194A	Auto Side marker — Amber (yellow) silicone coating — Heavy Duty <sup>(132)</sup>	14.0	.27A	—	Wedge	B	C-2F	—	1.06	2,500	—
18	194E	Truck Clearance Ext. Leads	14.0	.27A	2	Wedge, Wire Terminal <sup>(122)</sup>	B	C-2F	—	1.06	2,500	—
19	194E-1	Truck Clearance 3/16" leads up	14.0	.27A	2	Wedge, Wire Terminal <sup>(122)</sup>	B	C-2F	—	1.06	2,500	—
20	640	Indicator	14.0	.27A	2	Min Screw High Skirt	B	2-CF	.86	1.15	2,000	—
21	659	Garden Lighting	14.0	.27A	2	Wedge	B	2-CR	.63	1.06	2,000	—
22	1889	Auto — Heavy Duty	14.0	.27A	2	Miniature Bayonet	B	C-2F	.56	1.19	2,000	—
23	1893	Auto — Heavy Duty	14.0	.33A	2	Miniature Bayonet	B	C-2F	.62	1.19	7,500	—
24	193	Heavy Duty Truck	14.0	.33A	2	Wedge	B	C-2F	.56	1.07	15,000	—
25	193E	Heavy Duty Truck	14.0	.33A	2	Wedge	B	C-2F	.56	1.07	15,000	—
26	193E-1	Truck Clearance — 3/16" leads up	14.0	.33A	2	Wedge, Wire Terminal <sup>(122)</sup>	B	C-2F	—	1.06	7,500	—
27	168	Auto Instrument	14.0	.35A	3	Wedge	B	C-2F	.56	1.06	1,500	—
28	PC-168	Auto Instrument	14.0	.35A	3	Printed Circuit Socket	B	C-2F	.45	1.11	1,500	12
29	PC168B	Auto Inst. Blue	14.0	.35A	—	Printed Circuit Socket	B	C-2F	.45	1.11	1,500	12
30	2286D	Auto/Truck	14.0	.35A	2.7	Wire Term Down	B	2-CF	—	1.05	1,500	—
31	2286U	Auto/Truck	14.0	.35A	2.7	Wire Term Up	B	2-CF	—	1.05	1,500	—

<sup>(13)</sup> Supported

<sup>(122)</sup> This is a wire terminal lamp. The glass-to-metal seal (and tip where applicable) are susceptible to damage by thermal shock, and soldering or welding within 1/8" of the glass should be avoided as glass cracks and air leaks may develop. Solderability may be adversely affected by storage for an extended period in excess of six months or by storage in a high humidity environment.

Lamps with tinned leads would not be subject to these storage restrictions. Nickel-plated leads are not recommended for soldering; however their ability to be welded is not affected by these storage restrictions.

<sup>(132)</sup> Paint may peel, craze or discolor when subjected to excessive moisture heat, and freezing in housings with plugged drain holes or which otherwise leak or trap moisture.

<sup>(147)</sup> Differs from ANSI.



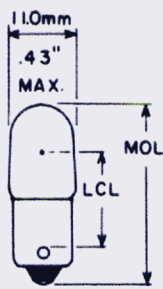

Fig. 76  
T-3/4

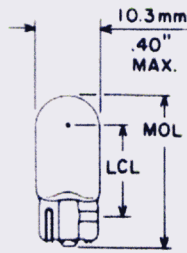

Fig. 77  
T-3/4

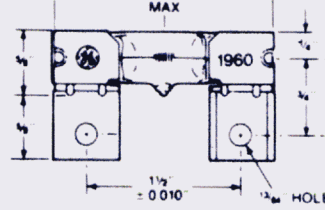

Fig. 105  
T-4

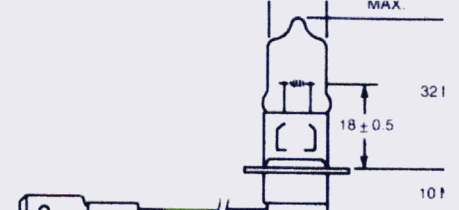

Fig. 123  
T-3 1/2

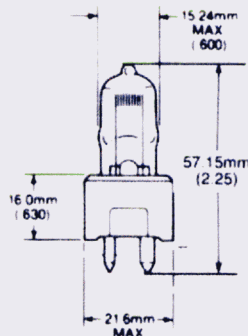

Fig. 109  
T-4

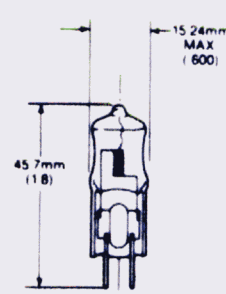

Fig. 112  
T-4

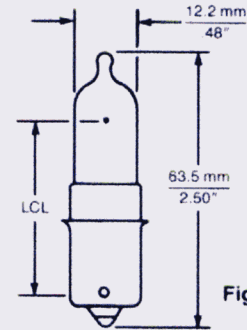

Fig. 133  
T-4

Line No.	GE Lamp No.	Primary Application	Design Volts	Design Watts or Amps	Mean Spherical Candle-Power (Approx.)	Base	Atmosphere B-Vac./C-Gas	Filament Designation	Light Center Length (Inches)	Max. Overall Length (Inches)	Rated Average Lab Life (Hours)	Fig. No.
----------	-------------	---------------------	--------------	----------------------	---------------------------------------	------	-------------------------	----------------------	------------------------------	------------------------------	--------------------------------	----------

T-3/4 BULB <sup>13</sup>/<sub>32</sub>" (10mm) DIAMETER (continued)

1	1813	Radio	14.4	.10A	.86	Miniature Bayonet	B	C-2V <sup>(13)</sup>	.62	1.19	1,000	76
2	1892	Auto and Indicator	14.4	.12A	.75	Miniature Bayonet	B	C-2F	.62	1.19	1,000	76
3	1818	Aircraft	24.0	.17A	3.30	Miniature Bayonet	B	C-2F <sup>(147)</sup>	.62	1.19	250	76
4	1843	Indicator <sup>(15)</sup>	28.0	.022A	.20	Miniature Bayonet	B	C-2F	.62	1.19	3,000	76
5	1819	Indicator	28.0	.04A	.34	Miniature Bayonet	B	C-2F	.62	1.19	2,500	76
6	585	Indicator	28.0	.04A	.30	Wedge	B	C-2F	.56	1.06	7,000 <sup>(75)(79)</sup>	77
7	656	Indicator	28.0	.06A	.62	Wedge	B	C-2F	.56	1.06	2,500	77
8	1829	Indicator	28.0	.07A	1.00	Miniature Bayonet	B	C-2F	.62	1.19	1,000	76
9	757	Indicator	28.0	.08A	.62	Miniature Bayonet	B	C-2F	.62	1.19	15,000 <sup>(43)(79)</sup>	76
10	657	Indicator	28.0	.08A	.62	Wedge	B	C-2F	.56	1.06	15,000 <sup>(43)(79)</sup>	77
11	1820	Indicator	28.0	.10A	1.60	Miniature Bayonet	B	C-2F	.62	1.19	1,000	76
12	400	Aircraft	28.0	.10A	1.60	Wedge	B	C-2F	.56	1.06	1,000	77
13	313	Aircraft	28.0	.17A	3.50	Miniature Bayonet	B	C-2F	.62	1.19	500	76
14	1864	Aircraft	28.0	.17A	3.00	Miniature Bayonet	B	C-2F	.62	1.19	1,500	76
15	464	Aircraft	28.0	.17A	3.00	Wedge	B	C-2F	.56	1.06	1,500	77
16	1873	Aircraft	28.0	.20A	3.00	Miniature Bayonet	B	C-2F	.62	1.19	7,000	76
17	1822	Indicator	36.0	.10A	2.10	Miniature Bayonet	B	C-2F	.62	1.19	1,000	76
18	1828	Indicator	37.5	.05A	.65	Miniature Bayonet	B	C-2F	.62	1.19	3,000	76
19	1835	Indicator	55.0	.05A	1.10	Miniature Bayonet	B	C-2F	.62	1.19	5,000	76

T-3/2 Bulb (11.5mm) DIAMETER

20	H3-55	Auto Auxillary <sup>(114)</sup>	12.0	55W	115	PK22S	C	C-6	.71	1.65	100 <sup>(5)</sup>	123
21	H3-100	Off Road Auxillary <sup>(114)</sup>	12.0	100W	187	PK22S	C	C-6	.71	1.65	50 <sup>(5)</sup>	123

T-4 BULB <sup>1</sup>/<sub>2</sub>" (13mm) DIAMETER

22	1983	Aircraft — Navigation — Quartz bulb — Halogen <sup>(114)</sup>	10.0	100W	130	Wire Terminal	C	C-8	1.25	1.80	2,000	112
23	1960	Instrument, Oscillograph — Quartz bulb — Halogen <sup>(114)</sup>	11.0	60W	90	Tab	C	CC-8	.75	2.25	1,000	105
24	795	Signal — Halogen <sup>(114)</sup>	12.8	50W	108	S.C. Bayonet	C	C6	1.25	2.50	200 <sup>(4)</sup>	133
25	1958	Aircraft — Quartz bulb — Halogen <sup>(114)</sup>	28.0	150W	250	Tab	C	CC-8	.75	2.25	300	105
26	1959	Aircraft — Quartz bulb — Halogen <sup>(114)</sup>	28.0	150W	240	Tab	C	CC-8 <sup>(3)</sup>	.75	2.25	300	105
27	1987	Aircraft — Quartz bulb — Halogen <sup>(114)</sup>	28.0	150W	240	D.C. Bayonet	C	CC-6	1.18	2.44	700	—
28	1986	Aircraft — Quartz bulb — Halogen <sup>(114)</sup>	28.0	250W	600	Wire Terminal	C	CC-6	1.03	2.00	100	—
29	1945	Marine — Quartz bulb — Halogen <sup>(114)</sup>	32.0	200W	360	S.C. Prefocus Collar Two Pin	C	CC-6	1.31	2.25	200	109

<sup>(14)</sup> At 14 volts.

<sup>(5)</sup> At 13.2 volts.

<sup>(13)</sup> Supported.

<sup>(15)</sup> This lamp is specially designed for a particular purchaser and may not be suitable for other uses because of its limited mechanical strength. Consult the nearest GE Lamp Sales Office for application information.

<sup>(43)</sup> Actual life depends upon use and environment. Theoretical design average life is 50,000 hours.

<sup>(75)</sup> Estimated. Based on limited test information.

<sup>(79)</sup> Life shown is AC voltage only. DC life will be approx. 50% of AC.

<sup>(114)</sup> CAUTION: This halogen-cycle bulb could shatter if scratched or damaged. Use appropriate protection for eyes and exposed skin when handling, using or disposing. Use in fixtures designed for the high temperature required for proper operation and that offer protection in case the bulb shatters. Turn power off when changing lamps. Allow lamp to cool before removal. For satisfactory performance: (1) limit seal and outer lead wire temperature to 350°C or lead wire deterioration may occur; (2) maintain a minimum bulb wall temperature of 250°C for operation of the halogen cycle; (3) remove grease or fingerprints from bulb by cleaning with a grease-free solvent; (4) operate at design volts.

<sup>(147)</sup> Differs from ANSI.

# Miniature Lamp Specifications

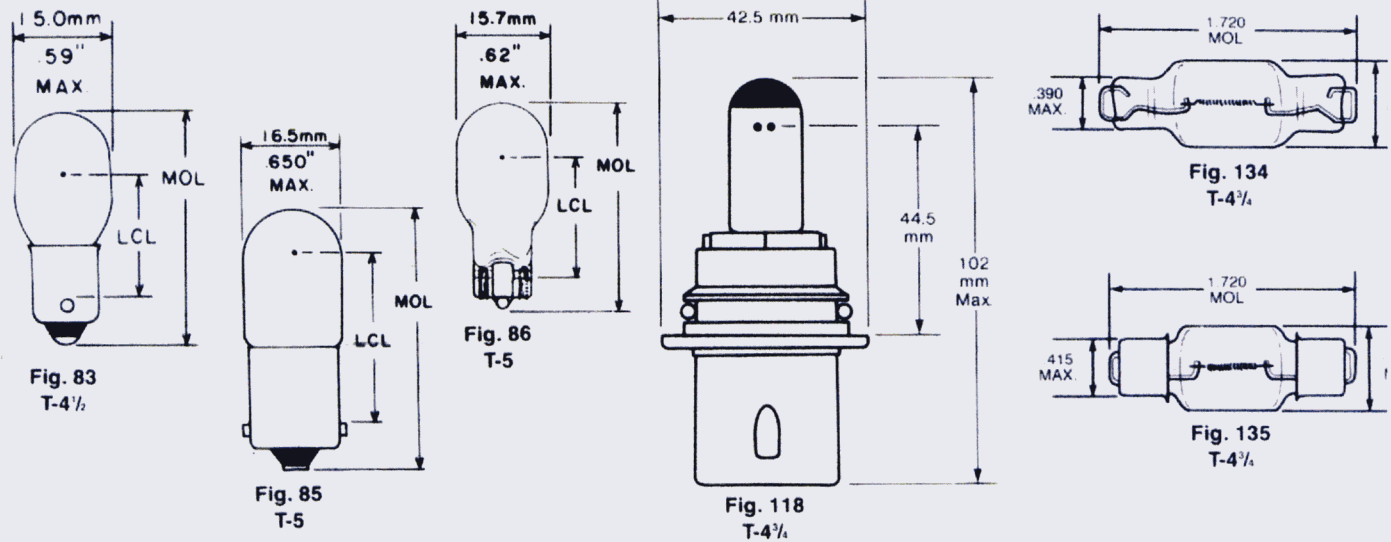

Line No.	GE Lamp No.	Primary Application	Design Volts	Design Watts or Amps	Mean Spherical Candle-Power (Approx.)	Base	Atmosphere B-Vac./C-Gas	Filament Designation	Light Center Length (Inches)	Max. Overall Length (Inches)	Rated Average Lab Life (Hours)	Fig. No.
----------	-------------	---------------------	--------------	----------------------	---------------------------------------	------	-------------------------	----------------------	------------------------------	------------------------------	--------------------------------	----------

## T-4 1/2 BULB 9/16" (14mm) DIAMETER

1	1886	Indicator	6.3	90A	4.2	Miniature Bayonet	C	C-2R	.75	1.38	3,000	8
2	957	Signal <sup>(144)</sup>	9.84	50A	4.6	Miniature Bayonet	C	C-2R	.5	1.38	200	8
3	1416	Marine <sup>(14)(144)</sup>	12.8	80	8.0	Miniature Bayonet	C	C-2R	.62	1.38	1,000	8
4	1414	Aircraft <sup>(144)</sup>	12.0	.46A	6.0	Miniature Bayonet	C	C-2R	.62	1.38	500	8
5	1495	Aircraft <sup>(14)</sup>	28.0	.30A	6.0	Miniature Bayonet	B	C-2F	.62	1.38	500	8
6	1495X	Aircraft — Gas filled	28.0	.30A	6.0	Miniature Bayonet	C	C-2F	.62	1.38	500	8

## T-4 3/4 BULB 19/32" (15.2mm) DIAMETER

7	9004	Auto Headlamp Replaceable Bulb	12.8	65W	138 <sup>(161)</sup>	Axial Plastic Prefocus	C	C-6	1.750"	4.02"	150 <sup>(4)</sup>	11
		High/Low Beam <sup>(131)(155)</sup>	12.8	45W	85 <sup>(161)</sup>	Axial Plastic Prefocus	C	C-6	(44.5mm)	(102mm)	320 <sup>(4)</sup>	11
8	9007	Auto Headlamp <sup>(131)(155)</sup>	12.8	65W	138 <sup>(161)</sup>	Axial Plastic Prefocus	C	C8	1.750"	4.02"	150 <sup>(4)</sup>	11
			12.8	55W	85 <sup>(161)</sup>	Axial Plastic Prefocus	C	C8	(44.5mm)	(102mm)	320 <sup>(4)</sup>	11
9	570	Truck Bed Light	12.8	2.10A	32.0	Rigid Loop	C	C8	—	1.72	600	13
10	577	Auto	12.8	1.40A	21.0	Double End Cap	C	C8	—	1.72	1,000	13

## T-5 BULB 5/8" (16mm) DIAMETER

11	1876	Special Serv., Photoelectric Scanner — Silver Plated contact (A.A. tol. 1/64")	3.5	2.50A	6.5	S.C. Bayonet	C	C-6	1.12	1.75	2,000	8
12	1876X	Special Serv., Photoelectric Scanner — Silver Plated contact (A.A. tol. 1/32")	3.5	2.50A	6.5	S.C. Bayonet	C	C-6	1.12	1.75	2,000	8
13	1434	Instrument, Photocell exciter — Silver Plated contact <sup>(8)</sup>	3.7	2.75A	11.0	S.C. Bayonet	C	C-6	1.12	1.75	100	8
14	1874	Instrument <sup>(8)</sup>	3.7	2.75A	11.0	S.C. Bayonet	C	C-6	1.12	1.75	100	8
15	914	Emergency Lighting	4.0	.90A	3.5	Wedge	C	C-6	.75	1.49	50	8
16	926	Emergency Lighting	4.0	1.80A	7.5	Wedge	C	C-2R	.81	1.49	50	8
17	909	Emergency Lighting	6.0	.62A	3.0	Wedge	C	C-2R	.81	1.49	50	8
18	939	Emergency Lighting	6.0	.90A	5.4	Wedge	C	C-2R	.81	1.49	50	8
19	927	Emergency Lighting	6.0	1.20A	8.0	Wedge	C	C-2R	.81	1.49	50	8
20	908	Emergency Lighting	6.0	1.50A	12.0	Wedge	C	C-2R	.81	1.49	50	8
21	1489	Instrument (Axial alignment tolerance 1/64")	6.5	2.75A	24.0	S.C. Bayonet	C	C-6	1.125	1.75	125	8

<sup>(4)</sup> At 14 volts.

<sup>(8)</sup> Bulb top selected for minimum glass imperfections.

<sup>(14)</sup> This lamp is specially designed for a particular purchaser and may not be suitable for other uses because of its excessive wattage requirements for the bulb size. Consult the nearest GE Lamp Sales Office for application information.

<sup>(131)</sup> **CAUTION:** This halogen-cycle lamp is pressurized and may shatter. Do not operate lamp in excess of rated voltage as this will increase lamp pressure and the risk of shattering. Protect lamp against abrasions and scratches and against liquids when lamp is operating.

To guard against personal injury, wear protective eyeglasses and clothing when handling lamp. Provide protective screen or shield with equipment in which lamp is installed or used. Turn power off when installing and before removing lamp. Dispose of lamp with care.

Because of heat generated by lamp, use only with sockets and housing designed to withstand the lamp's high operating tempera-

ture. Do not touch lamp when it is hot. Do not use lamp if it is cracked or broken. Do not use lamp if it is damaged or adversely affected by heat or drying. Allow lamp to cool before removing.

If further processing of the leads, such as bending, welding, crimping, etc., is required, care must be taken to assure that the lamp seal area is not strained, cracked, chipped, or otherwise damaged. Premature lamp failure may occur. For satisfactory performance: (1) limit seal and outer lead wire temperature to 350°C or lead wire deterioration may occur; (2) maintain a minimum bulb wall temperature of 250°C for operation of the halogen cycle; (3) operate at design volts.

<sup>(144)</sup> Potentially limited availability in large quantities at certain times of the year. Contact your GE Lamp Representative for current availability information.

<sup>(155)</sup> **CAUTION:** This halogen bulb contains gas under pressure and could shatter (with resultant flying fragments). Protect bulb against abrasion or scratches and against liquids when lighted. Turn on the bulb only when installed in a headlamp. Replace headlamp if damaged or cracked. Keep bulb out of reach of children.



# Miniature Lamp Specifications

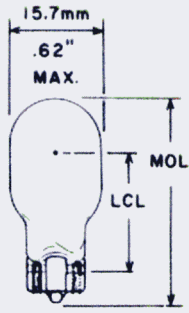

Fig. 86  
T-5

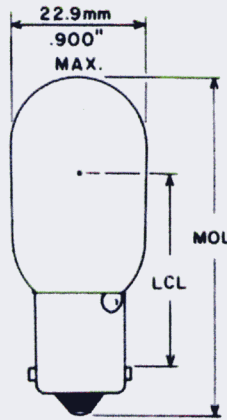

Fig. 87  
T-7

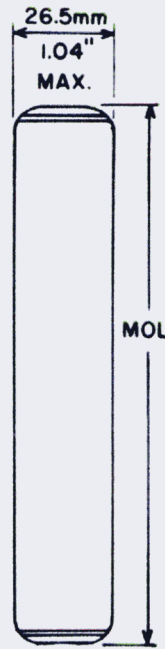

Fig. 89  
T-8

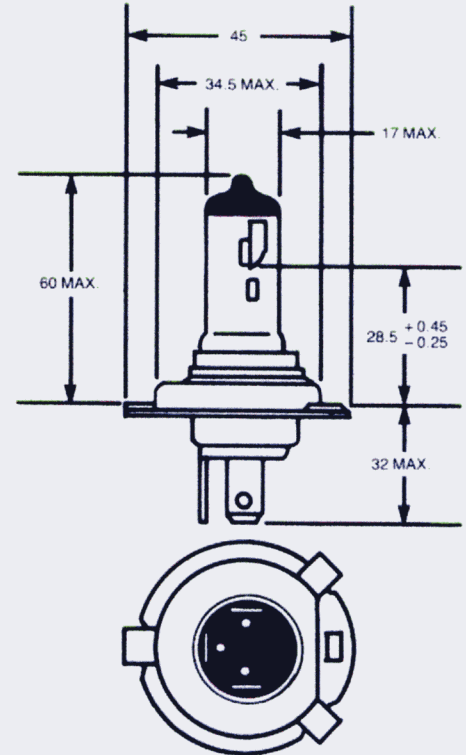

Fig. 128  
T-5

Line No.	GE Lamp No.	Primary Application	Design Volts	Design Watts or Amps	Mean Spherical Candle-Power (Approx.)	Base	Atmosphere B-Vac./C-Gas	Filament Designation	Light Center Length (Inches)	Max. Overall Length (Inches)	Rated Average Lab Life (Hours)	Fig. No.
<b>T-5 BULB 5/8" (16mm) DIAMETER</b>												
1	<b>H4</b>	Motorcycle Headlamp	12.0	60W 55W	100 60	P43T-38	C	C-8 C-8	1.12	3.62	100 <sup>(5)</sup> 200 <sup>(5)</sup>	128
2	<b>915</b>	Emergency Lighting	12.0	.75A	11	Wedge	C	C-2R	.81	1.49	50	86
3	<b>917</b>	Home Appliance	12.0	1.20A	10	Wedge	C	C-2F	.81	1.49	1,200	86
4	<b>918</b>	Garden & Security Lighting	12.8	.56A	6.5	Wedge	C	C-2R	.81	1.49	500	86
5	<b>923</b>	Garden & Security Lighting	12.8	.91A	12.5	Wedge	C	C-2R	.81	1.49	500	86
6	<b>922</b>	Auto, Heavy Duty	12.8	.98A	15	Wedge	C	C-2R	.81	1.49	200	86
7	<b>912</b>	Auto — Heavy Duty	12.8	1.00A	12	Wedge	C	C-2R	.81	1.49	1,000	86
8	<b>921</b>	Auto — Heavy Duty <sup>(121)</sup>	12.8	1.40A	21	Wedge	C	C-2R	.81	1.49	500	86
9	<b>906</b>	Auto — Heavy Duty	13.0	.69A	6	Wedge	C	C-2F	.81	1.49	1,000	86
10	<b>916</b>	Auto, Side Marker	13.5	.54A	2	Wedge	C	C-2F	.81	1.49	10,000	86
11	<b>904</b>	Auto — Heavy Duty	13.5	.69A	4	Wedge	C	C-2F	.81	1.49	5,000 <sup>(4)</sup>	86
<b>T-7 BULB 7/8" (22mm) DIAMETER</b>												
12	<b>1940</b>	Aircraft Marker <sup>(67)</sup>	14.0	3.57A	75	S.C. Bayonet	C	C-8Z	1.25	2.16	300	87
13	<b>1944</b>	Special Service — Silver contact <sup>(14)</sup>	14.0	3.57A	75	S.C. Bayonet	C	C-8Z	1.25	2.25	300	87
14	<b>1944X</b>	Special Service — Silver contact — Filament oriented <sup>(14)</sup>	14.0	3.57A	75	S.C. Bayonet	C	C-8Z	1.25	2.25	300	87
15	<b>1939X</b>	Aircraft Marker <sup>(67)</sup>	28.0	1.79A	70	S.C. Bayonet	C	C-2V <sup>(13)</sup>	1.25	2.16	300	87
<b>T-8 BULB 1" (22mm) DIAMETER</b>												
16	<b>ML20/ R-28</b>	Aircraft — Lumiline — Red	28.0	20W	—	Disk	B	2C-8	—	5.75 <sup>(12)</sup>	500	89
17	<b>ML20/ OF-28</b>	Aircraft — Lumiline — Inside Frosted	28.0	20W	—	Disk	B	2C-8	—	5.75 <sup>(12)</sup>	500	89

<sup>(4)</sup> At 14 volts.

<sup>(5)</sup> At 13.2 volts.

<sup>(12)</sup> Average overall length.

<sup>(13)</sup> Supported.

<sup>(14)</sup> This lamp is specially designed for a particular purchaser and may not be suitable for other uses because of its excessive wattage requirements

for the bulb size. Consult the nearest GE Lamp Sales Office for application information.

<sup>(67)</sup> Burning position—base up or base down only.

<sup>(121)</sup> To minimize the possible adverse effects on lamp life due to excessive wattage in relationship to bulb size: Burn Base Down to Base 45° Above Horizontal. Regardless of burning position, this excessive wattage will abnormally decrease light output during lamp life.

# Miniature Lamp Specifications

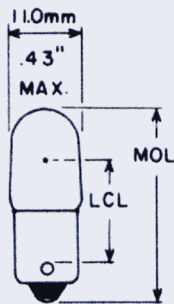

Fig. 76  
T-3/4

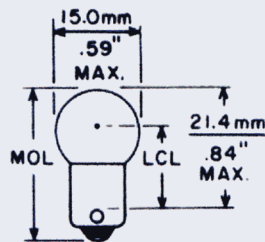

Fig. 92  
G-4 1/2

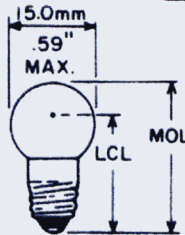

Fig. 91  
G-4 1/2

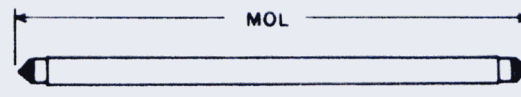

Fig. 93  
T-5

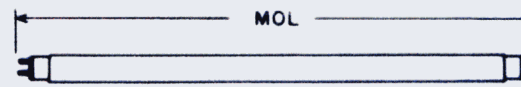

Fig. 94  
T-5

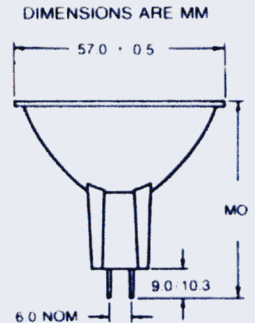

Fig. 104  
PAR-18

Line No.	GE Lamp No.	Primary Application	Design Volts	Design Watts or Amps	Mean Spherical Candle-Power (Approx.)	Base	Bulb	Filament Designation	Max Overall Length (Inches)	Rated Average Lab Life (Hours)	Fig. No.
----------	-------------	---------------------	--------------	----------------------	---------------------------------------	------	------	----------------------	-----------------------------	--------------------------------	----------

## FLASHER LAMP<sup>(70)\*\*</sup>

1	<b>407</b>	Hand Lantern — 4F cells <sup>(70)</sup>	4.9	30A	1.20	Miniature Screw	G-4 1/2	C-2R	1.07	50 <sup>(3)(116)</sup>	91
2	<b>267</b>	Indicator <sup>(70)</sup>	6.3	15A	.33	Miniature Bayonet	T-3 1/4	C-2R	1.19	5,000 <sup>(3)</sup>	76
3	<b>455</b>	Indicator <sup>(70)</sup>	6.5	50A	1.90	Miniature Bayonet	G-4 1/2	C-2R	1.07	500	92
4	<b>257</b>	Auto and Toy Train <sup>(70)</sup>	14.0	27A	1.60	Miniature Bayonet	G-4 1/2	C-2R	1.07	500 <sup>(3)</sup>	91
5	<b>258</b>	Toy Train <sup>(70)</sup>	14.0	27A	1.60	Miniature Screw	G-4 1/2	C-2R	1.07	500 <sup>(3)</sup>	91

## PAR-18 PLASTIC REFLECTOR — BULB 2 1/4" (57mm) DIAMETER

6	<b>HR9000</b>	Emergency Lighting <sup>(145)</sup>	6.0	7W	—	G-6 Two Pin	T-3 1/4	C-6	2.21	50	104
7	<b>HR9001</b>	Emergency Lighting <sup>(145)</sup>	6.0	12W	—	G-6 Two Pin	T-3 1/4	C-6	2.21	50	104
8	<b>HR9002</b>	Emergency Lighting <sup>(145)</sup>	12.0	12W	—	G-6 Two Pin	T-3 1/4	C-6	2.21	50	104

Line No.	GE Lamp No.	Primary Application	Design Volts	Design Watts or Amps	Approx. Lumens*	Base	Bulb	Filament Designation	Max Overall Length (Inches)	Rated Average Lab Life (Hours)	Fig. No.
----------	-------------	---------------------	--------------	----------------------	-----------------	------	------	----------------------	-----------------------------	--------------------------------	----------

## ELECTRIC DISCHARGE LAMPS — FLUORESCENT T-5 BULB 5/8" (16mm) DIAMETER

9	<b>5004CW</b>	Aircraft — Cool White <sup>(32)(71)</sup>	a.c.	4W	150	Miniature Pinless	T5		6 Nom.	7,500 <sup>(162)</sup>	93
10	<b>5004WW</b>	Aircraft — Warm White <sup>(32)(71)</sup>	a.c.	4W	140	Miniature Pinless	T5		6 Nom.	7,500 <sup>(162)</sup>	93
11	<b>5104WW</b>	Aircraft — Warm White <sup>(32)(71)</sup>	a.c.	4W	140	Miniature Bi-Pin	T5		6 Nom.	7,500 <sup>(162)</sup>	94
12	<b>5106WW</b>	Aircraft — Warm White <sup>(32)(71)</sup>	a.c.	6W	300	Miniature Bi-Pin	T5		9 Nom.	7,500 <sup>(162)</sup>	94
13	<b>5008CW</b>	Aircraft — Cool White <sup>(32)(71)</sup>	a.c.	8W	445	Miniature Pinless	T5		12 Nom.	7,500 <sup>(162)</sup>	93
14	<b>5008WW</b>	Aircraft — Warm White <sup>(32)(71)</sup>	a.c.	8W	435	Miniature Pinless	T5		12 Nom.	7,500 <sup>(162)</sup>	93
15	<b>5108WW</b>	Aircraft — Warm White <sup>(32)(71)</sup>	a.c.	8W	435	Miniature Bi-Pin	T5		12 Nom.	7,500 <sup>(162)</sup>	94
16	<b>5013CW</b>	Aircraft — Cool White <sup>(32)(71)</sup>	a.c.	13W	820	Miniature Pinless	T5		21 Nom.	7,500 <sup>(162)</sup>	93
17	<b>5013WW</b>	Aircraft — Warm White <sup>(32)(71)</sup>	a.c.	13W	790	Miniature Pinless	T5		21 Nom.	7,500 <sup>(162)</sup>	93
18	<b>5113WW</b>	Aircraft — Warm White <sup>(32)(71)</sup>	a.c.	13W	790	Miniature Bi-Pin	T5		21 Nom.	7,500 <sup>(162)</sup>	94

\*Measured at 100 hours.

\*\*Flasher-Filament<sup>(70)</sup> lamps have a bi-metal strip added to the filament mount to provide the flashing. Heat from the filament causes the strip to bend away from the lead wire, breaking the circuit. As the bi-metal strip cools, it returns to its original position against the lead wire and the lamp lights.

<sup>(3)</sup> Useful life.

<sup>(32)</sup> Designed and rated for operation in supplementary cathode preheat circuits for which specifications are available from the lamp manufacturer.

<sup>(70)</sup> These lamps produce a random flashing indication only. While the majority should flash between 40-160 flashes per minute at normal room temperature, some will be outside this range. As ambient temperature and/or input voltage changes, the flash rate may vary considerably. At rated voltage and room temperature most lamps will flash within 60 seconds.

<sup>(71)</sup> Use these lamps with auxiliary equipment specially designed to produce proper electrical values conforming to established specifications. For total load, add auxiliary watts to lamp watts.

<sup>(116)</sup> Life tests are performed on DC voltage only.

<sup>(145)</sup> CAUTION: This halogen-cycle lamp is pressurized and care should be taken to reduce risk of shattering. Do not operate lamp in excess of rated voltage as this will increase lamp pressure. Pro-

To guard against personal injury, use only in housings with a lens cover. Wear protective eyeglasses and clothing when handling lamp. Turn power off when installing and removing lamp. Dispose of lamp with care.

Because of heat generated by lamp, use only in sockets and housings designed to withstand the lamp's high operating temperatures. Do not operate in proximity to substances or materials that are flammable or adversely affected by heat or drying. Allow lamp to cool before removing.

The reflector has an unprotected aluminized surface. Corrosive, dusty, or moist environments may cause the reflector to degrade causing a reduction of light output. Periodically check the aluminized surface for degradation and replace if any occurs. For satisfactory performance: (1) avoid touching aluminized surface of reflector as it may cause degradation; (2) operate at design volts; (3) maintain a minimum bulb wall temperature of 250°C for opera-



# Neon Glow Indicator Lamps



Line No.	Lamp Number*	Circuit Volts? AC or DC	Nominal Watts	Nominal Current	Base	Maximum Overall Length in. (mm)	Average Useful Life (Hours)	Series† Resistance (Ohms)	Footnotes	Figure No.
T-2 APPROX. 1/4" (6.4mm) DIAMETER										
1	<b>A1H</b>	105-125	1/4	.0012	S.C. Midget Flanged	1/8" (15.9)	25,000	47K	165, 168, 169, 170, 171	1
2	<b>C7A(NE-2D)</b>	105-125	1/4	.0007	S.C. Midget Flanged	15/16" (23.8)	25,000	100K	164, 169	2
3	<b>C9A(NE-2J)</b>	105-125	1/4	.0019	S.C. Midget Flanged	15/16" (23.8)	25,000	30K	165, 168, 169, 170, 171	2
T-3 1/4 APPROX. 13/32" (10mm) DIAMETER										
4	<b>B1A(NE-51)</b>	105-125	1/5	.0003	Miniature Bayonet	1 1/8" (30.2)	15,000	220K	164	3
5	<b>B2A(NE-51H)</b>	105-125	1/4	.0012	Miniature Bayonet	1 1/8" (30.2)	25,000	47K	165, 168, 170, 171	3
T-4 1/2 APPROX. 9/16" (14mm) DIAMETER										
6	<b>B7A(NE-45)</b>	105-125	1/4	.002	Candelabra Screw	1 1/2" (38.9)	7,500	30K	164	6
7	<b>B9A(NE-48)</b>	105-125	1/4	.002	D.C. Bayonet	1 1/2" (38.1)	7,500	30K	164	5
8	<b>F3A(NE-57)</b>	105-125	1/4	.002	Candelabra Screw	1 1/2" (38.9)	7,500	30K	164, 166, 167	4
9	<b>F4A(NE-58)</b>	210-250	1/2	.002	Candelabra Screw	1 1/2" (38.9)	7,500	100K	164	6
S-11 APPROX. 1 3/8" (35mm) DIAMETER										
10	<b>J5A(NE-30)</b>	105-125	1	.012	Medium Screw	2 1/4" (57.2)	10,000	7.5K	164, 166	7
11	<b>J9A(NE-56)</b>	210-250	1	.005	Medium Screw	2 1/4" (57.2)	10,000	33K	164, 166	7

(164) Life to approximately 50% of initial output. Values shown apply to use on a-c unless otherwise shown. Life on d-c is approximately 60% of a-c values when d-c current is equal to R.M.S. a-c value. When equal d-c and rms a-c voltages and equal resistances are utilized, life will be approximately the same.

(165) For d-c operation of high, brightness lamps, use minimum of 150 circuit volts. Maximum initial breakdown voltage—95V a-c, 135V d-c in light.

(166) Center electrode connected to base shell.

(167) DC starting voltage is for lamp connected so that center electrode is negative.

(168) High brightness.

(169) Formed tip.

(170) Dark effect reduced.

(171) Values shown apply to use on a-c unless otherwise shown. End of life occurs when breakdown voltage increases to line voltage and lamp will no longer start. With equal d-c and R.M.S. a-c current life will be some what lower than the 60% value quoted for standard brightness lamp, and current and wattage will increase over a-c values shown.

\*Three character symbol is the new trade number for this lamp recorded with the American National Standards Institute. The old NE number is in parentheses.

†In order to properly control the lamp current, a ballast resistor must be used. Lamps having screw bases have the necessary resistor built-in. Those having bayonet bases and those listed with wire terminals do not have a built-in resistor. The tables show the value of the external resistor to be used for normal operation at indicated circuit volts, or the value of the built-in resistor where applicable.

## Festoon Type, Auto & Special Service Lamps

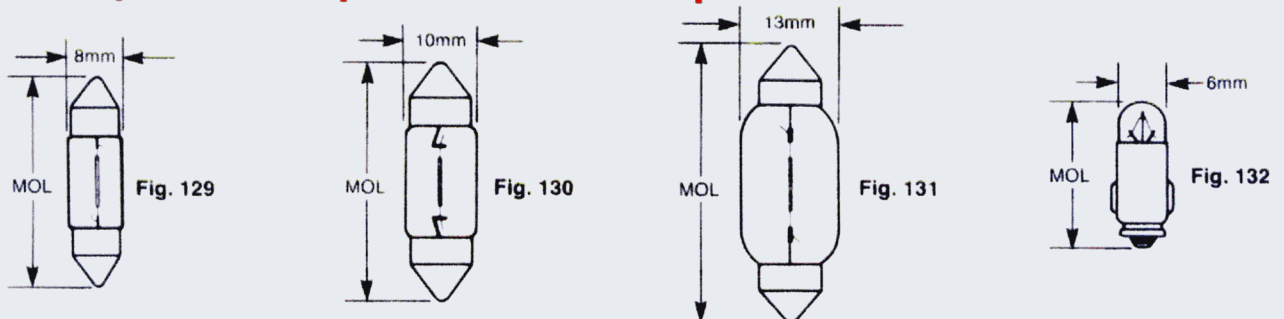

Line No.	GE Lamp No.	Primary Application Imported Auto	Design Volts	Design Watts or Amps	Mean Spherical Candle-Power (Approx.)	Base	Base Marking	Atmosphere B-Vac./C-Gas	Max. Overall Length (mm)	Rated Average Lab Life (Hours)	Fig. No.
12	<b>DE3022</b>	Dome & Courtesy	13.0	.38A	3.0	SV7MM*	12V 5W	B	29	1,000	129
13	<b>DE3423</b>	Dome & Courtesy	13.0	.39A	4.0	SV8.5MM*	12V 5W	B	37	150	131
14	<b>DE3175</b>	Dome & Courtesy	13.0	.77A	9.55	SV8.5MM*	12V 10W	B	31	400	130
15	<b>DE3425</b>	Dome & Courtesy	13.0	.77A	9.55	SV8.5MM*	12V 10W	B	37	400	131
16	<b>DE3021</b>	Dome & Courtesy	14.0	.24A	2.0	SV7MM*	12V 3W	B	28	1,000	129
17	<b>SE1274</b>	Dome & Courtesy	14.4	.12A	1.0	BA75MM**	12V 1.5W	B	19	500	132

\*Base on double-ended cone-shaped base attached to both ends of the lamp.

# Sealed Beam, Filaments & Bases (Typical)

## Bulbs

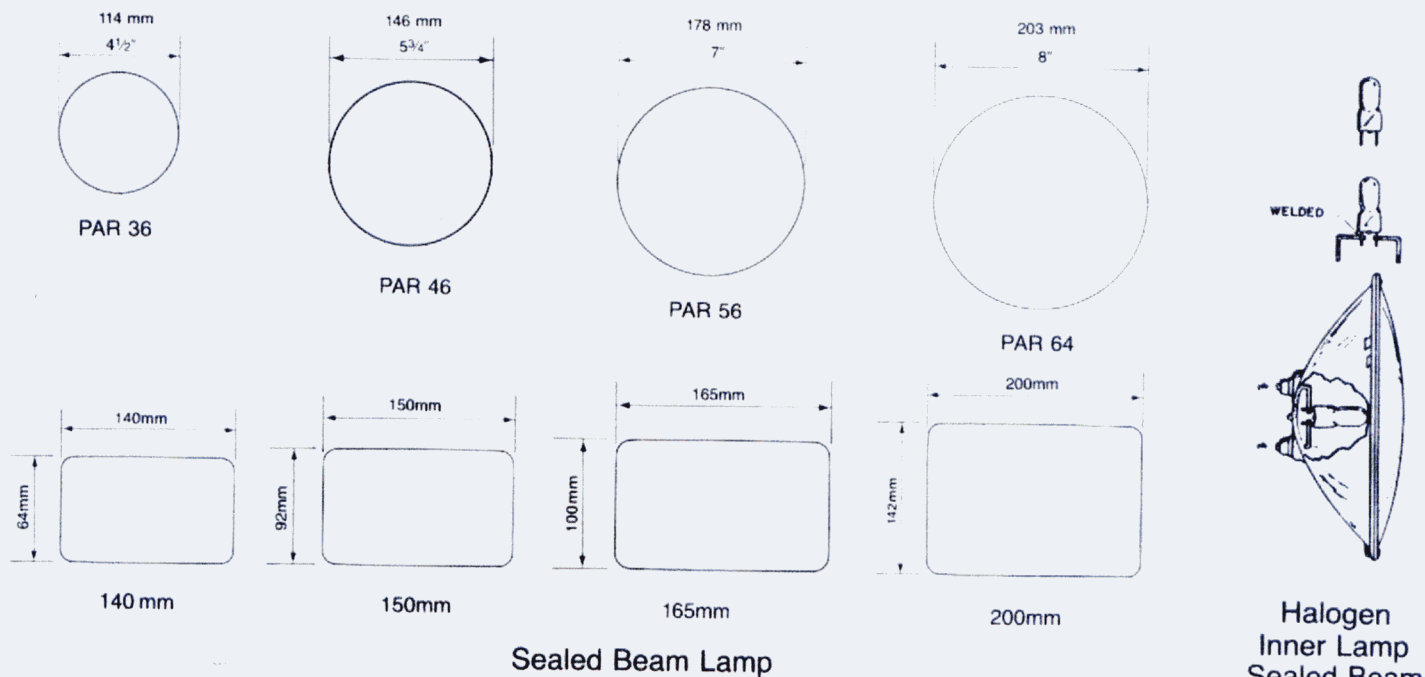

## Filaments

Filaments for sealed beam lamps may be a coil or a coiled coil wire (indicated by the letters C and CC respectively). Coiling the filament wire reduces gas losses and increases efficiency. The number following the coil identification letter(s) denotes the arrangement of the filament on the supports.

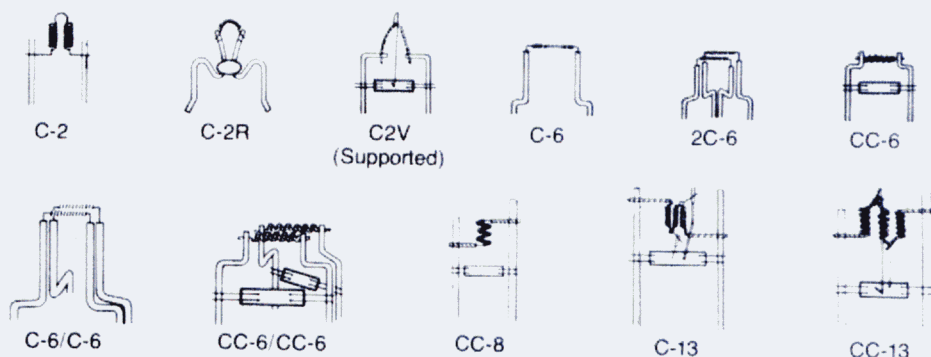

## Bases

Bases provide electrical contact to the lamp. The most common bases for sealed beam lamps are the screw terminal and contact lug types. Other types are also available, as illustrated.

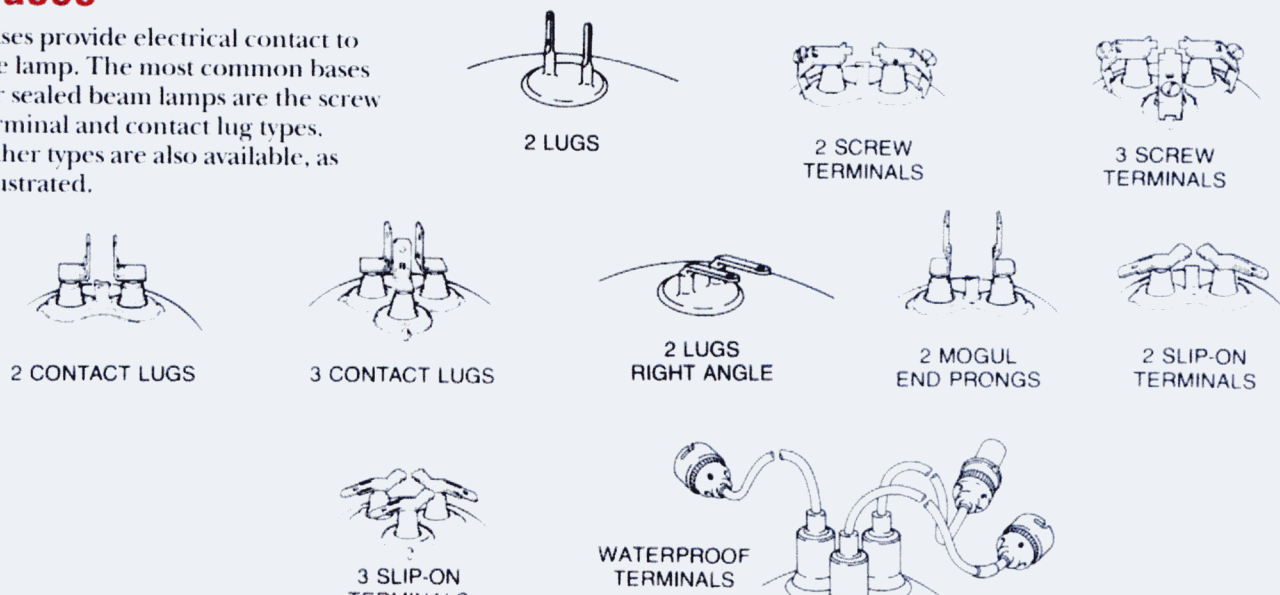



# Sealed Beam Lamp Specifications

Line No.	GE Lamp No.	Primary Application	Design Volts	Design Watts or Amps	Approx. Initial Maximum Beam C.P.	Approx. Total Spread to 10% Max. C.P. (Degrees)		Rated Average Lab Life (Hours)	Base	Filament Designation	Max. Overall Length	
						Horiz.	Vert.				mm	in
RECTANGULAR 72mm x 140mm ( 2.8 in x 5.5 in)												
1	H4362	Auto Daytime <sup>(118)</sup> Running Lite	12.8	22W		Canadian Spec.		640	2 Rt. Angle Lugs	C-6	76.2	3.0
2	H4360	Tractor <sup>(118)</sup>	12.8	37.5W	2,000	Trapezoid		320	2 Rt. Angle Lugs	C-6	76.2	3.0
RECTANGULAR 92mm x 150mm (3.6 in x 5.9 in)												
3	H9415	Auto, Fog-Halogen <sup>(118)</sup>	12.8	37.5W	12,000	45	5	200 <sup>(4)</sup>	2 Rt. Angle Lugs	C-6	76	3.0
4	H9415A	Auto Fog Amber <sup>(118)</sup>	12.8	37.5W	—	45	5	200 <sup>(4)</sup>	2 Rt. Angle Lugs	C-6	76	3.0
5	H9405	Spotlamp, Halogen <sup>(118)</sup>	12.8	50W	100,000	7	4	100	2 Rt. Angle Lugs	C-6	76	3.0
6	H9406	Tractor, Flood, Halogen <sup>(118)</sup>	12.8	50W	1,350	70	30	400 <sup>(4)</sup>	2 Rt. Angle Lugs	C-6	76	3.0
7	H9411	Tractor, Trapezoidal, Halogen <sup>(118)</sup>	12.8	50W	5,400	Trapezoidal		400 <sup>(4)</sup>	2 Rt. Angle Lugs	C-6	76	3.0
8	H9414	Tractor, Emergency Lighting, Medium Flood, Halogen <sup>(118)</sup>	12.8	50W	2,700	45	20	400 <sup>(4)</sup>	2 Rt. Angle Lugs	C-6	76	3.0
9	H9420	Auto, Driving — Halogen <sup>(118)</sup>	12.8	50W	47,000	15	5	200 <sup>(4)</sup>	2 Rt. Angle Lugs	C-6	76	3.0
10	H9421	Auto, Truck, Special Service — Halogen <sup>(118)</sup>	12.8	50W	14,000	45	8	200 <sup>(4)</sup>	2 Rt. Angle Lugs	C-6	76	3.0
11	H4703	Halogen Auto Headlamp, Low Beam Type LF <sup>(118)</sup>	12.8	55W	SAE Specifications			320 <sup>(4)</sup>	2 Lugs	C-8	85	3.4
12	H4701	Halogen Auto Headlamp High Beam Type UF <sup>(118)</sup>	12.8	65W	SAE Specifications			150 <sup>(4)</sup>	2 Lugs	C-8	85	3.4
RECTANGULAR 100mm x 165mm (4.2 in x 6.5 in)												
13	4651	Auto Headlamp, High Beam, Type 1A1	12.8	50W	SAE Specifications			200 <sup>(4)</sup>	2 Contact Lugs	C-6	121	4.8
14	H4651	Halogen Auto Headlamp, High Beam, Type 1A <sup>(118)(151)</sup>	12.8	50W	SAE Specifications			200 <sup>(4)</sup>	2 Contact Lugs	C-6	121	4.8
15	HP4651	Halogen Auto Headlamp, High Beam, Type 1A <sup>(118)(151)</sup>	12.8	50W	SAE Specifications			200 <sup>(4)</sup>	2 Contact Lugs	C-6	121	4.8
16	H5051	Halogen Truck Headlamp, High Beam, Type 1A <sup>(118)(151)</sup>	12.8	50W	SAE Specifications			500 <sup>(4)</sup>	2 Contact Lugs	C-6	121	4.8
17	4652	Auto Headlamp, Low Beam, Type 2A1 <sup>(26)</sup>	Hi 12.8 Lo 12.8	40W 60W	SAE Specifications			200 <sup>(4)</sup> 320 <sup>(4)</sup>	3 Contact Lugs	C-6	121	4.8
18	H4656	Halogen Auto Headlamp, Low Beam, Type 2A1 <sup>(118)(151)</sup>	Hi 12.8 Lo 12.8	35W 35W	SAE Specifications			200 <sup>(4)</sup> 320 <sup>(4)</sup>	3 Contact Lugs	C-6	121	4.8
19	HP4656	Halogen Auto Headlamp, Low Beam, Type 2A1 <sup>(118)(151)</sup>	Hi 12.8 Lo 12.8	35W 35W	SAE Specifications			200 <sup>(4)</sup> 320 <sup>(4)</sup>	3 Contact Lugs	C-6	121	4.8
20	H5062	Halogen Truck Headlamp, Low Beam, Type 2A1 <sup>(118)(151)</sup>	Hi 12.8 Lo 12.8	40W 55W	SAE Specifications			400 <sup>(4)</sup> 2000 <sup>(4)</sup>	3 Contact Lugs	C-6	121	4.8
21	H4666	Halogen Auto Headlamp, High/Low Beam, Type 2E1 <sup>(118)</sup>	Hi 12.8 Lo 12.8	65W 45W	SAE Specifications			150 <sup>(4)</sup> 320 <sup>(4)</sup>	3 Contact Lugs	C-8 C-6	121	4.8
22	4912-1	Auto/Truck Fog <sup>(81)</sup>	12.8	50W	14,000	40	7	300	Slip-on Terminals	C-6	115	4.5:
23	4913-1	Farm Tractor, Flood	12.8	50W	1,350	80	20	400 <sup>(4)</sup>	Slip-on Terminals	C-6	115	4.5:
24	4919-1	Farm Tractor <sup>(94)</sup>	12.8	50W	3,750	Trapezoidal		400 <sup>(4)</sup>	Slip-on Terminals	C-6	115	4.5:
25	H7935-1	Halogen Spotlamp <sup>(118)</sup>	12.8	50W	175,000	6 1/2	3 1/2	100	Slip-on Terminals	C-6	115	4.5:
26	4921-1	Auto/Truck, Special Service <sup>(109)</sup>	13.0	100W	—	40	7	300	Slip-on Terminals	C-6	115	4.5:
27	H7921-1	Halogen Auto/Truck, Special Service <sup>(109)(118)</sup>	12.8	50W	23,900	35	5	200 <sup>(4)</sup>	Slip-on Terminals	C-6	121	4.8

<sup>(4)</sup> At 14 volts.

<sup>(26)</sup> Lower beam filament shielded.

<sup>(81)</sup> 90° spherical shield above filament which masks all upward direct light.

<sup>(94)</sup> Trapezoidal beam, spread to 10% measured through the center of the beam pattern.

<sup>(109)</sup> Special fixture required for highway use.

<sup>(118)</sup> CAUTION: This sealed beam lamp has an inner halogen-cycle bulb.

This pressure-filled inner bulb could shatter if scratched or damaged. If the outer sealed envelope is intact, this will be no problem.

If the outer sealed envelope is broken, however, do not operate the lamp. Instead, carefully remove and dispose of the lamp by placing it in a used headlamp carton or other closed container. INFORMATION NOTICE: The inner bulb will continue to burn if the outer envelope is cracked or broken. Cracked or broken envelopes will result in reflector deterioration such as the discoloration and disappearance of the aluminized coating. This deterioration will also reduce light output. Promptly replace any sealed beam lamp showing reflector deterioration.

<sup>(151)</sup> Alternative construction may be adhesive seal.

<sup>(163)</sup> Plastic lens and reflector.

# Sealed Beam Lamp Specifications

Line No.	GE Lamp No.	Primary Application	Design Volts	Design Watts or Amps	Approx. Initial Maximum Beam C.P.	Approx. Total Spread to 10% Max. C.P. (Degrees)		Rated Average Lab Life (Hours)	Base	Filament Designation	Max. Overall Length	
						Horiz.	Vert.				mm	in
RECTANGULAR 142mm x 200mm (5.6 in x 7.9 in)												
1	<b>6052</b>	Auto Headlamp, Type 2B1 <sup>(26)</sup>	Hi Lo	12.8 12.8	65W 55W	SAE Specifications		150 <sup>(4)</sup> 320 <sup>(4)</sup>	3 Contact Lugs	C-6 C-6	138	5 <sup>1/16</sup>
2	<b>H6054</b>	Halogen										
3	<b>HP6054</b>	Auto Headlamp, Type 2B1 <sup>(118)(151)</sup> Halogen	Hi Lo	12.8 12.8	65W 35W	SAE Specifications		150 <sup>(4)</sup> 320 <sup>(4)</sup>	3 Contact Lugs	C-6 C-6	138	5 <sup>1/16</sup>
4	<b>H5054</b>	Halogen										
5	<b>6053</b>	Truck Headlamp, Type 2B1 <sup>(118)(151)</sup> Truck Headlamp, Type 2B1 <sup>(26)</sup>	Hi Lo Hi Lo	12.8 12.8 12.8 12.8	65W 42W 65W 66W	SAE Specifications		400 <sup>(4)</sup> 2000 <sup>(4)</sup> 150 <sup>(4)</sup> 640 <sup>(4)</sup>	3 Contact Lugs	C-6 C-6 C-6 C-6	138	5 <sup>1/16</sup>

## PAR36 BULB 114mm (4 1/2 in) DIAMETER

6	<b>4546</b>	Hand Lantern		4.7	0.5A	6,300	3	3	100	Screw Terminals	C-2R	70	2 <sup>3/4</sup>
7	<b>4546-1</b>	Hand Lantern		4.7	0.5A	6,300	3	3	100	Slip-on Terminals	C-2R	70	2 <sup>3/4</sup>
8	<b>4512</b>	Hand Lantern		4.7	0.5A	150	Trapezoidal		100	Screw Terminals	C-2R	70	2 <sup>3/4</sup>
9	<b>4547</b>	Hand Lantern		4.75	1.25A	20,000	3	3	100	Screw Terminals	C-2R	70	2 <sup>3/4</sup>
10	<b>4547-4</b>	Hand Lantern <sup>(152)</sup>		4.75	1.25A	20,000	3	3	100	Screw Terminals	C-2R	70	2 <sup>3/4</sup>
11	<b>H7556</b>	Halogen Emergency Bldg. Lighting <sup>(118)</sup>		6.0	6W	400	30	20	50	Screw Terminals	C-6	70	2 <sup>3/4</sup>
12	<b>7672-1</b>	Emergency Bldg. Lighting		6.0	7.2W	350	30	20	50	Slip-on Terminals	C-6	70	2 <sup>3/4</sup>
13	<b>7613</b>	Emergency Bldg. Lighting		6.0	8W	400	30	20	50	Screw Terminals	C-6	70	2 <sup>3/4</sup>
14	<b>7613-1</b>	Emergency Bldg. Lighting		6.0	8W	400	30	20	50	Slip-on Terminals	C-6	70	2 <sup>3/4</sup>
15	<b>H7550</b>	Halogen Hand Lantern <sup>(118)</sup>		6.0	8W	25,000	3	3	50	Screw Terminals	C-6	70	2 <sup>3/4</sup>
16	<b>H7551</b>	Halogen Emergency Bldg. Lighting <sup>(118)</sup>		6.0	8W	550	30	20	50	Screw Terminals	C-6	70	2 <sup>3/4</sup>
17	<b>H7552</b>	Halogen Emergency Bldg. Lighting <sup>(118)</sup>		6.0	10W	650	30	20	50	Screw Terminals	C-6	70	2 <sup>3/4</sup>
18	<b>H7553</b>	Halogen Emergency Bldg. Lighting <sup>(118)</sup>		6.0	12W	850	30	20	50	Screw Terminals	C-6	70	2 <sup>3/4</sup>
19	<b>H7554</b>	Halogen Emergency Bldg. Lighting <sup>(118)</sup>		6.0	20W	1,400	30	20	50	Screw Terminals	C-6	70	2 <sup>3/4</sup>
20	<b>4614</b>	Aircraft Navigation <sup>(82)</sup>		6.0	100W	85,000	11	6	300	Screw Terminals	C-6	70	2 <sup>3/4</sup>
21	<b>4516</b>	Spotlamp		6.2	30W	45,000	9	4	300	Screw Terminals	C-6	70	2 <sup>3/4</sup>
22	<b>4511</b>	Tractor		6.2	30W	2,300	Trapezoidal		300 <sup>(23)</sup>	Screw Terminals	C-6	70	2 <sup>3/4</sup>
23	<b>4042</b>	Emergency Bldg. Lighting		6.4	12W	1,100	45	20	150	Screw Terminals	C-6	70	2 <sup>3/4</sup>
24	<b>4014</b>	Emergency Bldg. Lighting		6.4	18W	1,500	50	25	200	Screw Terminals	C-6	70	2 <sup>3/4</sup>
25	<b>4667</b>	Moped Headlamp <sup>(17)</sup>		6.4	18W		SAE Specifications		200	Mogul End Prongs	C-6	79.4	3 <sup>1/8</sup>
26	<b>4510</b>	Tractor Flood, Emergency Bldg. Lighting		6.4	25W	800	80	20	300	Screw Terminals	C-6	70	2 <sup>3/4</sup>
27	<b>4308</b>	Headlamp, Horse-Drawn Vehicles		6.4	25W	24,000	—	—	300	Screw Terminals	C-6	70	2 <sup>3/4</sup>
28	<b>4515</b>	Spotlamp <sup>(82)</sup>		6.4	12W	3,000	—	—	150	3 Screw Terminals	C-6	70	2 <sup>3/4</sup>
				6.4	30W	55,000	5	5	100	Screw Terminals	C-6	70	2 <sup>3/4</sup>

<sup>(4)</sup> At 14 volts.

<sup>(17)</sup> Filament shielded.

<sup>(23)</sup> At 7 volts.

<sup>(26)</sup> Lower beam filament shielded.

<sup>(82)</sup> Hemispherical shield in front of filament which masks all direct light.

<sup>(96)</sup> Lens stippled.

<sup>(118)</sup> **CAUTION:** This sealed beam lamp has an inner halogen-cycle bulb. This pressure-filled inner bulb could shatter if scratched or damaged. If the outer sealed envelope is intact, this will be no problem. If the outer sealed envelope is broken, however, do not operate the

lamp. Instead, carefully remove and dispose of the lamp by placing it in a used headlamp carton or other closed container. INFORMATION NOTICE: The inner bulb will continue to burn if the outer envelope is cracked or broken. Cracked or broken envelopes will result in reflector deterioration such as the discoloration and disappearance of the aluminized coating. This deterioration will also reduce light output. Promptly replace any sealed beam lamp showing reflector deterioration.

<sup>(151)</sup> Alternative construction may be adhesive seal.

<sup>(152)</sup> Contains seating plane for special application.

<sup>(163)</sup> Plastic lens and reflector.



# Sealed Beam Lamp Specifications

Line No.	GE Lamp No.	Primary Application	Design Volts	Design Watts or Amps	Approx. Initial Maximum Beam C.P.	Approx. Total Spread to 10% Max. C.P. (Degrees)		Rated Average Lab Life (Hours)	Base	Filament Designation	Max. Overall Length	
						Horiz.	Vert.				mm	in
PAR36 BULB 114mm (4 1/2 in) DIAMETER (Continued)												
1	H4515	Spotlamp, Shielded Bulb <sup>(118)</sup>	6.4	30W	67,000	5 1/2	4	100	Screw Terminals	C-6	70	2 3/4
2	H7555	Halogen Emergency Bldg Lighting <sup>(118)</sup>	12.0	8W	550	30	20	50	Screw Terminals	C-6	70	2 3/4
3	H7557	Emergency Bldg Lighting Halogen-Cycle <sup>(118)</sup>	12.0	12W	850	30	20	50	Screw Terminals	C-6	70	2 3/4
4	4044	Emergency Bldg. Lighting	12.0	12W	1,100	50	25	150	Screw Terminals	C-6	70	2 3/4
5	4044-1	Emergency Bldg. Lighting	12.0	12W	1,100	50	25	150	Slip-on Terminals	C-6	70	2 3/4
6	H7514	Garden & Security Lighting, Halogen <sup>(118)</sup>	12.8	9W	750	50	25	300	Screw Terminals	C-6	70	2 3/4
7	4414	Warning Signal, Emergency Bldg. Lighting, Garden and Security Lighting	12.8	18W	1,500	50	25	300	Screw Terminals	C-6	70	2 3/4
8	4414-1	Signal	12.8	18W	1,500	50	25	300	Slip-on Terminals	C-6	70	2 3/4
9	4414A	Turn Signal, Warning Signal Yellow Lens	12.8	18W	450	50	25	300	Screw Terminals	C-6	70	2 3/4
10	4414R	Turn Signal, Warning Signal Red Lens	12.8	18W	275	50	25	300	Screw Terminals	C-6	70	2 3/4
11	7414Y	Signal, Light Yellow Lens	12.8	18W	1,000	50	25	300	Screw Terminals	C-6	70	2 3/4
12	4446	Emergency Bldg. Lighting	12.8	25W	400	80	80	300	Screw Terminals	C-6	70	2 3/4
13	4405	Spotlight <sup>(82)</sup>	12.8	30W	50,000	6	5	100	Screw Terminals	C-6	70	2 3/4
14	H4405	Spotlamp, Shielded Bulb <sup>(118)</sup>	12.8	30W	66,000	7	4	100	Screw Terminals	C-6	70	2 3/4
15	4416	Spotlamp, Signal	12.8	30W	35,000	11	4	300	Screw Terminals	C-6	70	2 3/4
16	4416-1	Spotlamp, Signal	12.8	30W	35,000	11	4	300	Slip-on Terminals	C-6	70	2 3/4
17	4416A	Signal, Yellow Lens Cover	12.8	30W	26,000	11	4	300	Screw Terminals	C-6	70	2 3/4
18	4416B	Signal, Outside Blue	12.8	30W	—	11	4	300	Screw Terminals	C-6	70	2 3/4
19	4416R	Signal, Red Lens Cover	12.8	30W	4,000	11	4	300	Screw Terminals	C-6	70	2 3/4
20	4406	Tractor, Flood <sup>(134)</sup>	12.8	35W	600	80	30	300 <sup>(4)</sup>	Screw Terminals	C-6	70	2 3/4
21	4406-1	Tractor, Flood <sup>(134)</sup>	12.8	35W	600	80	30	300 <sup>(4)</sup>	Slip-on Terminals	C-6	70	2 3/4
22	4409X	Farm Tractor <sup>(137)</sup>	12.8	35W	600	80	30	300 <sup>(4)</sup>	Screw Terminals	C-6	70	2 3/4
23	4410	Backup Lamp, Tractor Flood	12.8	35W	600	80	30	300 <sup>(4)</sup>	Screw Terminals	C-6	70	2 3/4
24	4411	Tractor	12.8	35W	3,000	Trapezoidal		300 <sup>(4)</sup>	Screw Terminals	C-6	70	2 3/4
25	4411-1	Tractor	12.8	35W	3,000	Trapezoidal		300 <sup>(4)</sup>	Slip-on Terminals	C-6	70	2 3/4
26	4422	Tractor	12.8	35W	600	75° Cone		300 <sup>(4)</sup>	Screw Terminals	C-6	70	2 3/4
27	4603	Tractor <sup>(35)(94)(143)</sup>	12.8	35W	2,800	Trapezoidal		300 <sup>(4)</sup>	Screw Terminals	C-6	70	2 3/4
28	4603X	Tractor <sup>(142)</sup>	12.8	35W	2,800	Trapezoidal		300 <sup>(4)</sup>	Screw Terminals	C-6	70	2 3/4
29	4415	Fog <sup>(81)</sup>	12.8	35W	9,000	40	5	300	Screw Terminals	C-6	70	2 3/4
30	4415A	Fog, Yellow Lens <sup>(81)</sup>	12.8	35W	7,000	40	5	300	Screw Terminals	C-6	70	2 3/4
31	7400	Signal, Rotating Beacon	12.8	35W	33,000	12	5	300	Slip-on Terminals	C-6	70	2 3/4
32	7400-1	Signal, Rotating Beacon	12.8	35W	33,000	12	5	300	Screw Terminals	C-6	70	2 3/4
33	7400R	Signal, Rotating Beacon, Red Lens <sup>(108)</sup>	12.8	35W	4,900	12	5	300	Slip-on Terminals	C-6	70	2 3/4
34	H7600	Halogen Signal, Rotating Beacon <sup>(118)</sup>	12.8	37.5W	60,000	9	4 1/2	300	Screw Terminals	C-6	70	2 3/4
35	H7601-1	Halogen Signal <sup>(118)</sup>	12.8	37.5W	43,000	50	25	300	Slip-on Terminals	C-6	70	2 3/4

<sup>(4)</sup> At 14 volts

<sup>(17)</sup> Filament shielded

<sup>(35)</sup> Outside transparent red coating on reflector. Transparent round window in reflector below base terminals

<sup>(81)</sup> 90° spherical shield above filament which masks all upward direct light

<sup>(82)</sup> Hemispherical shield in front of filament which masks all direct light

<sup>(94)</sup> Trapezoidal beam, spread to 10% measured through the center of the beam pattern.

<sup>(108)</sup> The process of applying this permanent red finish may impart a slight iridescence and gradation of color to the lens, but this will not affect the lamp's performance

<sup>(118)</sup> **CAUTION:** This sealed beam lamp has an inner halogen-cycle bulb. This pressure-filled inner bulb could shatter if scratched or damaged. If the outer sealed envelope is intact, this will be no problem. If the outer sealed envelope is broken, however, do not operate the lamp. Instead, carefully remove and dispose of the lamp by placing it in a used headlamp carton or other closed container. **INFORMATION NOTICE:** The inner bulb will continue to burn if the outer envelope is cracked or broken. Cracked or broken envelopes will result in reflector

deterioration such as the discoloration and disappearance of the aluminumized coating. This deterioration will also reduce light output. Promptly replace any sealed beam lamp showing reflector deterioration

<sup>(134)</sup> Wide flood beam lamps are used for forward illumination as well as for lighting implements at the rear of the tractor.

<sup>(137)</sup> Not interchangeable with lamp 4409. This lamp must be used in a housing equipped with a 32 candlepower bulb (1156) that provides the proper light for the tail lamp application. It should not be used in housings that contain a 15 candlepower bulb (1003 or 1004).

<sup>(142)</sup> Not interchangeable with lamp 4603. The 4603X lamp must be used in a housing equipped with a 21 candlepower bulb (1141) that provides the light for the tail lamp application. It should not be used in housings that contain a 15 candlepower bulb (1003 or 1004).

<sup>(143)</sup> Not interchangeable with lamp 4603X. Do not use in a housing that contains a 21 candlepower bulb (1141) or a 32 candlepower bulb (1156) for tail lamp use, or premature fading or peeling of the red coating will occur. The lamp should be checked from time to time to ensure that the emission of the proper color light has not been affected. If the emission has been affected, the lamp should be replaced to ensure that you have

# Sealed Beam Lamp Specifications

Line No.	GE Lamp No.	Primary Application	Design Volts	Design Watts or Amps	Approx. Initial Maximum Beam C.P.	Approx. Total Spread to 10% Max. C.P. (Degrees)		Rated Average Lab Life (Hours)	Base	Filament Designation	Max. Overall Length	
						Horiz.	Vert.				mm	in
PAR36 BULB 114mm (4 1/2 in) DIAMETER (Continued)												
1	<b>H7616</b>	Halogen Spotlamp <sup>(118)</sup>	12.8	37.5W	70,000	7	4	300	Screw Terminals	C-6	70	2 3/4
2	<b>4440X</b>	Tractor	12.8	40W	6,000	40	7	320 <sup>(4)</sup>	3 Contact Lugs	C-6	76	3
			12.8	40W	4,500	33	9	320 <sup>(4)</sup>		C-6		
3	<b>4440X-1</b>	Tractor	12.8	40W	6,000	40	7	320 <sup>(4)</sup>	3 Slip-on Terminals	C-6	70	2 1/4
			12.8	40W	4,500	33	9	320 <sup>(4)</sup>		C-6		
4	<b>4460X</b>	Tractor	12.8	40W	6,500	22	10	320 <sup>(4)</sup>	3 Screw Terminals	C-6	70	2 1/4
			12.8	40W	5,000	22	13	320 <sup>(4)</sup>		C-6		
5	<b>H7606</b>	Tractor, Flood							Screw Terminals	C-6	70	2 1/4
6	<b>H7610</b>	Halogen — Cycle <sup>(118)</sup>	12.8	50W	1,000	80	30	400 <sup>(4)</sup>	Screw Terminals	C-6	70	2 1/4
7	<b>H7610-1</b>	Halogen Tractor <sup>(118)</sup>	12.8	50W	5,200	Trapezoidal		400 <sup>(4)</sup>	Screw Terminals	C-6	70	2 1/4
8	<b>H7614</b>	Halogen Flood <sup>(118)</sup>	12.8	50W	2,000	70	30	100	Slip-on Terminals	C-6	70	2 1/4
9	<b>H7604</b>	Halogen Spotlamp <sup>(118)</sup>	12.8	50W	100,000	7	5	100	Screw Terminals	C-6	70	2 1/4
10	<b>H7675-1</b>	Halogen Special Service <sup>(109)(118)</sup>	12.8	50W	15,000	35	7	200 <sup>(4)</sup>	Screw Terminals	C-6	70	2 1/4
11	<b>4425R</b>	C.I.M. Stop/Tail, Red Lens <sup>(108)</sup>	12.8	50W	500			200 <sup>(4)</sup>	3 Screw Terminals	C-6	70	2 1/4
			12.8	18W	100			200 <sup>(4)</sup>		C-6		
12	<b>4461</b>	Tractor	12.8	60W	6,000	Trapezoidal		300 <sup>(4)</sup>	Screw Terminals	C-6	70	2 1/4
13	<b>4464</b>	Signal, Rotating Beacon	12.8	60W	50,000	12	5	300 <sup>(4)</sup>	Screw Terminals	C-6	70	2 1/4
14	<b>4464R</b>	Signal, Rotating Beacon Red Lens <sup>(108)</sup>							Screw Terminals	C-6	70	2 1/4
15	<b>4466</b>	Tractor <sup>(134)</sup>	12.8	60W	7,000	12	5	300 <sup>(4)</sup>	Screw Terminals	C-6	70	2 1/4
16	<b>4460X-4</b>	Tractor	12.8	60W	1,000	80	30	300 <sup>(4)</sup>	Screw Terminals	C-6	70	2 1/4
			12.8	60W	10,000	22	10	320 <sup>(4)</sup>	3 Screw Terminals	C-6	70	2 1/4
			12.8	60W	8,000	22	13	320 <sup>(4)</sup>		C-6		
17	<b>H4460X</b>	Tractor <sup>(118)</sup>	12.8	40W	11,000	22	10	320 <sup>(4)</sup>	3 Screw Terminals	C-6	70	2 1/4
			12.8	40W	8,500	22	13	320 <sup>(4)</sup>		C-6		
18	<b>H7607</b>	Tractor Flood	12.8	65W	1,500	Non-Symmetrical		600 <sup>(4)</sup>	Screw Terminals	C-6	70	2 1/4
19	<b>4675</b>	Special Service <sup>(8)(109)</sup>	13.0	75W	15,000	40	7	300	Slip-on Terminals	C-6	70	2 1/4
20	<b>4509</b>	Aircraft Landing Spotlamp <sup>(98)</sup>	13.0	100W	110,000	12	6	25	Screw Terminals	C-6	70	2 1/4
21	<b>4509X</b>	Marine Spotlamp <sup>(82)</sup>	13.0	100W	110,000	12	6	25	Screw Terminals	C-6	70	2 1/4
22	<b>4519</b>	Marine	13.0	100W	30,000	40	7	25	Screw Terminals	C-6	70	2 1/4
23	<b>4595</b>	Aircraft Navigation	13.0	100W	60,000	14	6	300	Screw Terminals	C-6	70	2 1/4
24	<b>4700</b>	Spot/Flood	13.0	100W	100,000	12	7	25	3 Screw Terminals	C-6	70	2 1/4
			13.0	100W	50,000	17	18	25		C-6		
25	<b>4313</b>	Aircraft Landing	13.0	250W	140,000	16	7	25	Screw Terminals	C-6	70	2 1/4
26	<b>Q4631</b>	Halogen Quartzline <sup>®</sup> Aircraft Landing, Wing Inspection <sup>(14)(118)</sup>	13.0	250W	80,000	13	12	500	Screw Terminals	C-6	70	2 1/4
27	<b>Q4632</b>	Halogen Quartzline <sup>®</sup> Aircraft Logo <sup>(14)(96)(118)</sup>	13.0	250W	75,000	14	12	500	Screw Terminals	C-6	70	2 1/4
28	<b>4402A</b>	C.I.M. Signal	28.0	50W	1,000	50	25	400	Screw Terminals	C-6	70	2 1/4
29	<b>4502</b>	Auto Headlamp, Military	28.0	50W	10,000	40	7	400	Screw Terminals	C-6	70	2 1/4
30	<b>4505</b>	Aircraft Navigation	28.0	50W	45,000	11	5	400	Screw Terminals	CC-6	70	2 1/4
31	<b>4589</b>	Aircraft Cockpit Flood, C.I.M. Flood	28.0	50W	5,000	Trapezoidal		400	Screw Terminals	CC-6	70	2 1/4
32	<b>4593</b>	Aircraft In-Air Refueling	28.0	50W	1,500	80	30	400	Screw Terminals	CC-6	70	2 1/4
33	<b>4825R</b>	C.I.M. Stop/Tail Red Lens <sup>(98)(108)</sup>	28.0	50W	200			200	3 Screw Terminals	C-2V	70	2 1/4
			28.0	18W	40			200		C-2V		
34	<b>4750</b>	C.I.M. Headlamp	28.0	60W	5,000	36	12	800	Screw Terminals	2C-6	70	2 1/4
35	<b>4752</b>	C.I.M. Flood	28.0	60W	2,000	50	25	800	Screw Terminals	2C-6	70	2 1/4
36	<b>4591</b>	Aircraft Landing	28.0	100W	90,000	12	6	25	Screw Terminals	CC-6	70	2 1/4

<sup>(4)</sup> At 14 volts.

<sup>(14)</sup> This lamp is specially designed for a particular purchaser and may not be suitable for other uses because of its excessive wattage requirements for the bulb size. Consult the nearest GE Lamp Sales Office for application information.

<sup>(81)</sup> 90° spherical shield above filament which masks all upward direct light.

<sup>(82)</sup> Hemispherical shield in front of filament which masks all direct light.

<sup>(96)</sup> Lens stippled.

<sup>(98)</sup> Not for highway use.

<sup>(108)</sup> The process of applying this permanent red finish may impart a slight iridescence and gradation of color to the lens, but this will not affect the lamp's performance.

<sup>(109)</sup> Special fixture required for highway use.

<sup>(118)</sup> **CAUTION:** This sealed beam lamp has an inner halogen-cycle bulb. This pressure-filled inner bulb could shatter if scratched or damaged. If the outer sealed envelope is intact, this will be no problem. If the outer sealed envelope is broken, however, do not operate the lamp. Instead, carefully remove and dispose of the lamp by placing it in a used headlamp carton or other closed container. **INFORMATION NOTICE:** The inner bulb will continue to burn if the outer envelope is cracked or broken. Cracked or broken envelopes will result in reflector deterioration such as the discoloration and disappearance of the aluminumized coating. This deterioration will also reduce light output. Promptly replace any sealed beam lamp showing reflector deterioration.

<sup>(134)</sup> Wide flood beam lamps are used for forward illumination as well as for lighting implements at the rear of the tractor.



# Sealed Beam Lamp Specifications

Line No.	GE Lamp No.	Primary Application	Design Volts	Design Watts or Amps	Approx. Initial Maximum Beam C.P.	Approx. Total Spread to 10% Max. C.P. (Degrees)		Rated Average Lab Life (Hours)	Base	Filament Designation	Max. Overall Length	
						Horiz.	Vert.				mm	in
PAR36 BULB 114mm (4 1/2 in) DIAMETER (Continued)												
1	4594	Aircraft Navigation	28.0	100W	70,000	13	7	300	Screw Terminals	CC-6	70	2 3/4
2	4627	Aircraft Flood	28.0	100W	3,000	80	30	300	Screw Terminals	CC-6	70	2 3/4
3	4811	Auto Headlamp, Military	28.0	110W				400		CC-6		
			28.0	55W	SAE Specifications			400	3 Contact Lugs	CC-6	76	3
4	4626	Aircraft Taxiing	28.0	150W	25,000	40	9	300	Screw Terminals	CC-6	70	2 3/4
5	4587	Aircraft Taxiing <sup>(14)</sup>	28.0	250W	40,000	40	13	25	Screw Terminals	CC-8	70	2 3/4
6	4596	Aircraft Landing <sup>(14)</sup>	28.0	250W	150,000	11	12	25	Screw Terminals	CC-8	70	2 3/4
7	4350	Electric Truck Work Light <sup>(15)</sup>	36.0	60W	2,100	Trapezoidal		400	Slip-on Terminals	C-2V	70	2 3/4
8	4340	Electric Truck Work Light <sup>(15)</sup>	48.0	80W	2,500	Trapezoidal		400	Slip-on Terminals	C-2V	70	2 3/4

## PAR46 BULB 146mm (5 3/4 in) DIAMETER

9	4019	Tractor	6.2	30W	1,200	Trapezoidal		300 <sup>(23)</sup>	Screw Terminals	C-6	95	3 3/4
10	4013	Tractor, Flood	6.4	25W	800	80	20	300	Screw Terminals	C-6	95	3 3/4
11	4535	Spotlamp <sup>(82)</sup>	6.4	30W	95,000	5 1/2	4	100	Screw Terminals	C-6	95	3 3/4
12	4020	Cycle Headlamp	6.4	30W				300		C-6		
			6.4	30W	SAE Specifications			300	3 Contact Lugs	C-6	102	4
13	4031	Auto Headlamp, Military	6.4	45W				300		C-6		
			6.4	45W	SAE Specifications			500	3 Contact Lugs	C-6	102	4
14	4531	Auto Headlamp, Military	12.5	40W	30,000	20	5	400	Screw Terminals	C-6	95	3 3/4
15	4439X	Special Service <sup>(98)</sup>	12.8	18W	900	60	20	300	2 Contact Lugs	C-6	102	4
16	4435	Spotlamp <sup>(82)</sup>	12.8	30W	75,000	5	5	100	Screw Terminals	C-6	95	3 3/4
17	4420	Cycle Headlamp <sup>(146)</sup>	12.8	30W				300		C-6		
			12.8	30W	SAE Specifications			300	3 Contact Lugs	C-6	102	4
18	4412	Fog <sup>(81)</sup>	12.8	35W	11,000	40	7	300	Screw Terminals	C-6	95	3 3/4
19	4412A	Fog, Yellow <sup>(81)</sup>	12.8	35W	8,800	40	7	300	Screw Terminals	C-6	95	3 3/4
20	4412A-1	Fog, Yellow <sup>(81)</sup>	12.8	35W	8,800	40	7	300	Slip-on Terminals	C-6	95	3 3/4
21	4413	Tractor, Flood <sup>(134)</sup>	12.8	35W	1,100	80	20	300 <sup>(4)</sup>	Screw Terminals	C-6	95	3 3/4
22	4413R	Signal, Red Lens <sup>(108)</sup>	12.8	35W	200	80	20	300 <sup>(4)</sup>	Screw Terminals	C-6	95	3 3/4
23	4419	Tractor <sup>(94)</sup>	12.8	35W	1,600	Trapezoidal		300 <sup>(4)</sup>	Screw Terminals	C-6	95	3 3/4
24	4427	Tractor, Flood <sup>(35)(107)</sup>	12.8	35W	1,200	80	20	300 <sup>(4)</sup>	Screw Terminals	C-6	95	3 3/4
25	4436	Signal	12.8	35W	60,000	10	4	300	Screw Terminals	C-6	95	3 3/4
26	4436R	Signal, Red Lens <sup>(108)</sup>	12.8	35W	9,000	10	4	300	Screw Terminals	C-6	95	3 3/4
27	H5006	Halogen										
		Auto Headlamp, Hi	12.8	35W				200 <sup>(4)</sup>		C-6		
		Low Beam Type 2C1 <sup>(118)</sup> , Lo	12.8	35W	SAE Specifications			320 <sup>(4)</sup>	3 Contact Lugs	C-6	102	4
28	H5506	Halogen										
		Truck Headlamp, Hi	12.8	40W				400 <sup>(4)</sup>		C-6		
		Low Beam Type 2C1 <sup>(118)</sup> , Lo	12.8	55W	SAE Specifications			2,000 <sup>(4)</sup>	3 Contact Lugs	C-6	102	4
29	4000	Auto Headlamp, Hi	12.8	37.5W				200 <sup>(4)</sup>		C-6		
		Low Beam Type 2C1 <sup>(26)</sup> , Lo	12.8	60W	SAE Specifications			320 <sup>(4)</sup>	3 Contact Lugs	C-6	102	4
30	4040	Truck Headlamp, Hi	12.8	37.5W				300 <sup>(4)</sup>		C-6		
		Low Beam Heavy Duty, Type 2C1 <sup>(26)(146)</sup> , Lo	12.8	60W	SAE Specifications			500 <sup>(4)</sup>	3 Contact Lugs	C-6	102	4
31	4001	Auto Headlamp, High Beam Type 1C1	12.8	37.5W	SAE Specifications			300 <sup>(4)</sup>	2 Contact Lugs	C-6	102	4
32	5712HI	Auto Headlamp High Beam —										
		Left Hand Drive	12.8	50W	ECE Specifications			200 <sup>(4)</sup>	2 Contact Lugs	C-6	102	4
33	5731	Auto Headlamp Low Beam —										
		Left Hand Drive Hi	12.8	37.5W	ECE Specifications			320 <sup>(4)</sup>	3 Contact Lugs	C-6	102	4
		Lo	12.8	60W				150 <sup>(4)</sup>		C-6		

<sup>(4)</sup> At 14 volts.

<sup>(14)</sup> This lamp is specially designed for a particular purchaser and may not be suitable for other uses because of its excessive wattage requirements for the bulb size. Consult the nearest GE Lamp Sales Office for application information.

<sup>(15)</sup> This lamp is specially designed for a particular purchaser and may not be suitable for other uses because of its limited mechanical strength. Consult the nearest GE Lamp Sales Office for application information.

<sup>(23)</sup> At 7 volts.

<sup>(26)</sup> Lower beam filament shielded.

<sup>(35)</sup> Outside transparent red coating on reflector. Transparent round window in reflector below base terminals.

<sup>(81)</sup> 90° spherical shield above filament which masks all upward direct light.

<sup>(82)</sup> Hemispherical shield in front of filament which masks all direct light.

<sup>(94)</sup> Trapezoidal beam, spread to 10% measured through the center of the beam pattern.

<sup>(98)</sup> Not for highway use.

<sup>(107)</sup> The coating on this lamp is made and applied using high-quality materials. Like most coatings, it may fade or peel over a period of time, and

care should be taken to avoid damage caused by scratching or abrasion. Also, the lamp should be checked from time to time to ensure that the emission of the proper color light has been affected.

<sup>(108)</sup> The process of applying this permanent red finish may impart a slight iridescence and gradation of color to the lens, but this will not affect the lamp's performance.

<sup>(118)</sup> **CAUTION:** This sealed beam lamp has an inner halogen-cycle bulb. This pressure-filled inner bulb could shatter if scratched or damaged. If the outer sealed envelope is intact, this will be no problem. If the outer sealed envelope is broken, however, do not operate the lamp. Instead, carefully remove and dispose of the lamp by placing it in a used headlamp carton or other closed container. INFORMATION NOTICE: The inner bulb will continue to burn if the outer envelope is cracked or broken. Cracked or broken envelopes will result in reflector deterioration such as the discoloration and disappearance of the aluminized coating. This deterioration will also reduce light output. Promptly replace any sealed beam lamp showing reflector deterioration.

<sup>(134)</sup> Wide flood beam lamps are used for forward illumination as well as for lighting implements at the rear of the tractor.

<sup>(146)</sup> Ceramic bridge.

# Sealed Beam Lamp Specifications

Line No.	GE Lamp No.	Primary Application	Design Volts	Design Watts or Amps	Approx. Initial Maximum Beam C.P.	Approx. Total Spread to 10% Max. C.P. (Degrees)		Rated Average Lab Life (Hours)	Base	Filament Designation	Max. Overall Length	
						Horiz.	Vert.				mm	in
PAR46 BULB 146mm (5 3/4 in) DIAMETER (continued)												
1	4001R	Auto, Signal	12.8	37.5W	—	—	—	300 <sup>(4)</sup>	2 Contact Lugs	C-6	102	4
2	H7612	Halogen Fog <sup>(178)</sup>	12.8	37.5W	15,000	40	7	450	Screw Terminals	C-6	95	3 3/4
3	4434A	School Bus Signal, Amber Lens	12.8	40W	1,000	55	25	100	Screw Terminals	C-6	95	3 1/2
4	4459	Tractor <sup>(94)</sup>	12.8	40W	1,400	Trapezoidal		320 <sup>(4)</sup>	Screw Terminals	C-6	95	3 1/2
5	4431	Auto Headlamp, Military	12.8	40W	1,300	Trapezoidal		320 <sup>(4)</sup>	3 Slip-on Terminals	C-6	84	3 1/5
6	H5001	Halogen Auto Headlamp High Beam, Type 1C1 <sup>(118)</sup>	12.8	45W	—	SAE Specifications		320 <sup>(4)</sup>	3 Contact Lugs	C-6	102	4
7	H5501	Halogen Truck Headlamp High Beam, Type 1C1 <sup>(118)</sup>	12.8	35W	—	SAE Specifications		200 <sup>(4)</sup>	2 Contact Lugs	C-6	102	4
8	H7609	Halogen Tractor Flood <sup>(118)</sup>	12.8	50W	—	SAE Specifications		500 <sup>(4)</sup>	2 Contact Lugs	C-6	102	4
9	H7619	Halogen Tractor <sup>(94)(118)</sup>	12.8	50W	2,200	80	20	400 <sup>(4)</sup>	Screw Terminals	C-6	95	3 3/4
10	H7621-1	Halogen Auto/Truck Special Service <sup>(109)(118)</sup>	12.8	50W	6,000	Trapezoidal		400 <sup>(4)</sup>	Screw Terminals	C-6	95	3 3/4
11	H7635	Halogen Spotlamp <sup>(118)</sup>	12.8	50W	20,000	50	7	200 <sup>(4)</sup>	Slip On Terminals	C-6	95	3 1/2
12	H7635-X	Halogen Spotlamp <sup>(118)</sup>	12.8	50W	160,000	6 1/2	4	100	Screw Terminals	C-6	95	3 3/4
13	4467	Cycle Headlamp <sup>(146)</sup>	12.8	50W	160,000	6 1/2	4	100	Screw Terminals	C-6	95	3 3/4
14	4492	Snowmobile Headlamp <sup>(98)</sup>	12.8	35W	—	SAE Specifications		320 <sup>(4)</sup>	3 Contact Lugs	C-6	102	4
15	4478	C.I.M. Flood	12.8	60W	21,000	—	—	300	3 Contact Lugs	C-6	102	4
16	4421	Auto/Truck, Special Service <sup>(82)(109)</sup>	13.0	60W	19,000	—	—	300	2 Contact Lugs	C-6	102	4
17	4537	Aircraft Landing <sup>(20)(83)(98)</sup>	13.0	100W	1,600	56	32	800 <sup>(4)</sup>	2 Contact Lugs	2C-6	102	4
18	4537-2	Spotlamp <sup>(20)(98)</sup>	13.0	100W	23,000	50	7	300	Slip-on Terminals	C-6	95	3 3/4
19	4537X	Marine Spotlamp <sup>(20)(82)</sup>	13.0	100W	200,000	11	6	25	Screw Terminals	C-6	80	3 1/2
20	4522	Aircraft Landing <sup>(83)</sup>	13.0	100W	200,000	11	6	25	Screw Terminals	C-6	80	3 1/2
21	4636-3	Signal	13.0	250W	290,000	12	10	25 <sup>(138)</sup>	Screw Terminals	C-2 <sup>(92)</sup>	80	3 1/2
22	4635	Aircraft Landing <sup>(14)</sup>	14.0	80W	90,000	9	7 1/2	200	Combination	2C-6	95	3 1/2
23	4530	Signal, Flashing <sup>(86)</sup>	16.5	450W	325,000	14	15	25	Screw Terminals	C-8	95	3 1/2
24	4578	C.I.M. Flood	26.0	5.3A	100,000	11	11	50	Screw Terminals	4CC-8	95	3 3/4
25	4880	C.I.M. Headlamp	28.0	60W	1,600	55	30	800	2 Contact Lugs	2C-6	102	4
26	4579	C.I.M. Headlamp	28.0	80W	6,000	—	—	800	2 Contact Lugs	2C-6	102	4
27	4570X	Tractor	28.0	60W	24,000	25	25	400	CC-6	CC-6	102	4
28	4570	Aircraft Taxiing	28.0	150W	11,000	7	7	400	3 Contact Lugs	CC-6	102	4
29	4571	Flood, Special Service	28.0	150W	32,000	50	9	300	Screw Term	CC-6	95	3 3/4
30	4572	Auto Flood, Military	28.0	150W	32,000	50	9	300	Screw Terminals	CC-6	95	3 3/4
31	4551	Aircraft Taxiing	28.0	150W	7,000	80	25	300	Screw Terminals	CC-6	95	3 3/4
32	4553	Aircraft Landing <sup>(83)</sup>	28.0	250W	4,500	55	55	300	Screw Terminals	CC-6	95	3 3/4
			28.0	250W	75,000	50	10	25 <sup>(138)</sup>	Screw Terminals	CC-6	95	3 3/4
			28.0	250W	300,000	11	12	25	Screw Terminals	CC-8	80	3 1/2

\*Screws come preassembled into terminals.

<sup>(4)</sup> At 14 volts.

<sup>(14)</sup> This lamp is specially designed for a particular purchaser and may not be suitable for other uses because of its excessive wattage requirements for the bulb size. Consult the nearest GE Lamp Sales Office for application information.

<sup>(20)</sup> Slightly rounded cover.

<sup>(82)</sup> Hemispherical shield in front of filament which masks all direct light.

<sup>(83)</sup> 120° cylindrical shield positioned to the side of the filament.

<sup>(86)</sup> Filament construction designed especially for military flashing signal service. Consult GE Lamp Product Planning and Application before recommending for other applications.

<sup>(92)</sup> Filament segments parallel.

<sup>(94)</sup> Trapezoidal beam, spread to 10% measured through the center of the beam pattern.

<sup>(98)</sup> Not for highway use.

<sup>(109)</sup> Special fixture required for highway use.

<sup>(118)</sup> **CAUTION:** This sealed beam lamp has an inner halogen-cycle bulb. This pressure-filled inner bulb could shatter if scratched or damaged. If the outer sealed envelope is intact, this will be no problem. If the outer sealed envelope is broken, however, do not operate the lamp. Instead, carefully remove and dispose of the lamp by placing it in a used headlamp carton or other closed container. **INFORMATION NOTICE:** The inner bulb will continue to burn if the outer envelope is cracked or broken. Cracked or broken envelopes will result in reflector deterioration such as the discoloration and disappearance of the aluminized coating. This deterioration will also reduce light output. Promptly replace any sealed beam lamp showing reflector deterioration.

<sup>(138)</sup> Life under specified test conditions: Cycled 5 minutes on and 5 minutes off.

<sup>(146)</sup> Ceramic bridge.



# Sealed Beam Lamp Specifications

Line No.	GE Lamp No.	Primary Application	Design Volts	Design Watts or Amps	Approx. Initial Maximum Beam C.P.	Approx. Total Spread to 10% Max. C.P. (Degrees)		Rated Average Lab Life (Hours)	Base	Filament Designation	Max. Overall Length	
						Horiz.	Vert.				mm	in

## PAR46 BULB 146mm (5 3/4 in) DIAMETER (continued)

1	<b>4532</b>	Aircraft	28.0	250W	75,000	12	19	100	Screw Terminals	CC8	95	3 1/4
2	<b>4554</b>	Aircraft Taxiing <sup>(14)</sup>	28.0	150W	14,500	16	19	100	Screw Terminals	C2V	80	3 1/4
3	<b>Q4554</b>	Halogen Quartzline <sup>®</sup> Aircraft Taxiing <sup>(14)(118)</sup>	28.0	450W	90,000	50	16	25		CC-8		
4	<b>4580</b>	Aircraft Landing <sup>(14)(118)</sup>	28.0	450W	65,000	50	11	100		CC-6		
5	<b>4581</b>	Aircraft Landing <sup>(14)(20)</sup>	28.0	450W	400,000	13	14	10	Screw Terminals	CC-8	95	3 1/2
6	<b>4582</b>	Aircraft/Helicopter Flood <sup>(14)</sup>	28.0	450W	400,000	13	14	10	Screw Terminals	CC-8	80	3 1/4
7	<b>Q4597</b>	Halogen Quartzline <sup>®</sup> Aircraft Flood <sup>(14)(118)</sup>	28.0	450W	20,000	50	55	10	Screw Terminals	CC-8	95	3 1/2
8	<b>Q4566</b>	Halogen Quartzline <sup>®</sup> Aircraft <sup>(14)(118)</sup>	28.0	450W	16,000	60	35	1,000	Screw Terminals	CC-6	84	3 1/16
9	<b>Q4681</b>	Halogen Quartzline <sup>®</sup> Aircraft Landing <sup>(14)(118)</sup>	28.0	450W	150,000	16	12	1,000	Screw Terminals	CC-6	84	3 1/16
			28.0	450W	310,000	15	9	50	Screw Terminals	CC-6	67	2 3/4

## PAR56 BULB 178mm (7 in) DIAMETER

10	<b>6006</b>	Auto Headlamp <sup>(26)</sup>	6.1	50W	SAE Specifications			300	3 Contact Lugs	C-6	127	5
11	<b>4545</b>	Marine Searchlight <sup>(82)</sup>	6.2	40W				500		100		
12	<b>4543</b>	Marine Spotlight	12.0	100W	225,000	9	5	50	Screw Terminals	C-6	114	4 1/2
13	<b>6014</b>	Auto Headlamp, Type 2D1 <sup>(26)</sup>	12.8	60W	SAE Specifications			200 <sup>(4)</sup>	3 Contact Lugs	C-6	127	5
14	<b>H6024</b>	Halogen Auto Headlamp, Type 2D1 <sup>(118)</sup>	12.8	50W				320 <sup>(4)</sup>		150 <sup>(4)</sup>		
15	<b>H5024</b>	Halogen Truck Headlamp, Type 2D1 <sup>(118)</sup>	12.8	35W	SAE Specifications			320 <sup>(4)</sup>	3 Contact Lugs	C-6	127	5
			12.8	65W	SAE Specifications			400 <sup>(4)</sup>	3 Contact Lugs	C-6	127	5
16	<b>6015</b>	Auto/Truck Headlamp, Heavy Duty, Type 2D1 <sup>(26)(146)</sup>	12.8	50W	SAE Specifications			2000 <sup>(4)</sup>	3 Contact Lugs	C-6	127	5
			12.8	50W	SAE Specifications			300 <sup>(4)</sup>	3 Contact Lugs	C-6	127	5
			12.8	50W	SAE Specifications			500 <sup>(4)</sup>	3 Contact Lugs	C-6	127	5
17	<b>7014</b>	Auto Headlamp	12.8	45W	ECE Specifications			320 <sup>(4)</sup>	3 Contact Lugs	C-6	127	5
18	<b>7021HI</b>	Left Hand Drive Auto Headlamp	12.8	60W				150 <sup>(4)</sup>		320 <sup>(4)</sup>		
			12.8	50W	ECE Specifications			320 <sup>(4)</sup>	3 Contact Lugs	C-6	127	5
			12.8	75W	ECE Specifications			150 <sup>(4)</sup>	3 Contact Lugs	C-6	127	5
19	<b>6045</b>	Signal	26.0	170W	230,000	9	8	100	Screw Term	CC-6	114	4 1/2
20	<b>4800</b>	Auto Headlamp, Military	28.0	50W				400		400		
			28.0	40W	SAE Specifications			400	3 Contact Lugs	CC-6	127	5
21	<b>4860</b>	Auto Headlamp, Military	28.0	80W	SAE Specifications			400	3 Contact Lugs	CC-6	127	5
			28.0	60W	SAE Specifications			400	Waterproof Terminals	CC-6	127	5
22	<b>4863</b>	Auto Headlamp Military <sup>(26)</sup>	28.0	80W	SAE Specifications			400	Waterproof Terminals	CC-6	127	5
			28.0	60W	SAE Specifications			400	Waterproof Terminals	CC-6	127	5
23	<b>4541</b>	Aircraft Landing <sup>(34)(83)</sup>	28.0	450W	470,000	15	11	25	Screw Terminals	C-13	114	4 1/2

## PAR64 BULB 203MM (8 in) DIAMETER

24	<b>4552</b>	Aircraft Landing <sup>(83)</sup>	28.0	250W	500,000	7	8	25 <sup>(138)</sup>	Screw Terminals	CC-8	95	3 1/2
25	<b>4559</b>	Aircraft Landing <sup>(83)</sup>	28.0	600W	600,000	11	12	25 <sup>(138)</sup>	Screw Terminals	CC-8	95	3 1/2
26	<b>Q4559</b>	Halogen Quartzline <sup>®</sup> Aircraft Landing <sup>(118)</sup>	28.0	600W	600,000	12	8	100 <sup>(138)</sup>	Screw Terminals	CC-6	95	3 1/2
27	<b>Q4559X</b>	Halogen Quartzline <sup>®</sup> Aircraft Landing <sup>(118)</sup>	28.0	600W	765,000	11	7 1/2	100 <sup>(138)</sup>	Screw Terminals	CC-6	95	3 1/2
28	<b>Q4629</b>	Halogen Quartzline <sup>®</sup> Aircraft Logo Light <sup>(118)</sup>	28.0	600W	20,000	55	35	1000	Screw Terminals	CC-6	122	4 7/16
29	<b>4557</b>	Aircraft Landing/Taxiing <sup>(14)</sup>	28.0	1,000W	540,000	11	15	25	Screw Terminals	CC-8	95	3 1/2
			28.0	400W	100,000	25	11	100 <sup>(138)</sup>	3 Screw Terminals	CC-6		
30	<b>5557</b>	Aircraft Landing/Taxiing <sup>(14)</sup>	28.0	1,000W	540,000	11	15	50	Screw Terminals	CC-8	95	3 1/2
			28.0	400W	100,000	25	11	100 <sup>(138)</sup>	3 Screw Terminals	C-6	95	3 1/2
31	<b>4555</b>	Aircraft Landing <sup>(14)(119)</sup>	115.0	1,000W	600,000	20	11	25 <sup>(138)</sup>	Screw Terminals	C-13	95	3 1/2

<sup>(4)</sup> At 14 volts

<sup>(14)</sup> This lamp is specially designed for a particular purchaser and may not be suitable for other uses because of its excessive wattage requirements for the bulb size. Consult the nearest GE Lamp Sales Office for application information.

<sup>(18)</sup> Rounded cover

<sup>(20)</sup> Slightly rounded cover.

<sup>(26)</sup> Lower beam filament shielded

<sup>(34)</sup> Clear round window in reflector below base terminals.

<sup>(82)</sup> Hemispherical shield in front of filament which masks all direct light.

<sup>(83)</sup> 120° cylindrical shield positioned to the side of the filament.

<sup>(118)</sup> CAUTION: This sealed beam lamp has an inner halogen-cycle bulb. This pressure-filled inner bulb could shatter if scratched or damaged. If the outer sealed envelope is intact, this will be no problem.

If the outer sealed envelope is broken, however, do not operate the lamp. Instead, carefully remove and dispose of the lamp by placing it in a used headlamp carton or other closed container. INFORMATION NOTICE: The inner bulb will continue to burn if the outer envelope is cracked or broken. Cracked or broken envelopes will result in reflector deterioration such as the discoloration and disappearance of the aluminized coating. This deterioration will also reduce light output. Promptly replace any sealed beam lamp showing reflector deterioration.

<sup>(119)</sup> CAUTION: This lamp operates at 120 volts. Use only in properly insulated housings designed for this type lamp. Turn power off when installing or removing lamps.

<sup>(138)</sup> Life under specified test conditions: Cycled 5 minutes on and 5 minutes off.

<sup>(146)</sup> Ceramic bridge.

# GE LIGHTING SALES OFFICES AND CUSTOMER SERVICE CENTERS

## GE LIGHTING HEADQUARTERS

CLEVELAND, OHIO Nela Park, Cleveland, OH

44112 (216) 266-2121

## SALES OFFICES

To obtain Sales Information

City	Address	Zip No.	Area Code	Telephone No.
ATLANTA, GA	6145 Barfield Rd., Suite 100 Commercial & Industrial Consumer Products	30328		(404) 250 3820 (404) 250-3801 (301) 290-1050
BALTIMORE, MD	7115 A Thomas Edison Dr., Columbia, MD	21046		(617) 320 4200
BOSTON, MA	990 Washington St., Suite 219 North, Dedham, MA	02026 28211		(704) 362 4367 (704) 362-4373
CHARLOTTE, NC	1900 Rexford Rd., Suite 500 Commercial & Industrial Consumer Products			(708) 671 2149 (708) 671 2133
CHICAGO, IL	4333 Trans World Road, Schiller Park, IL	60176		
CINCINNATI, OH	Northmark Business Center II 10123 Alliance Road, Suite 100 P.O. Box 42730	45242-4707		
CLEVELAND, OH	Commercial & Industrial Consumer Products Nela Park, E. Cleveland			(513) 243 8900 (513) 243 8903
DALLAS, TX	Commercial & Industrial Consumer Products 2080 McDaniel, Carrollton, TX P.O. Box 115035 (Zip 75011 5035)	75006		(216) 346 5572 (216) 266 8359
DENVER, CO	Commercial & Industrial Consumer Products 14272 E. Evans Ave., Aurora, CO	80014		(214) 888 0548 (214) 888 0566
DETROIT, MI	Commercial & Industrial Consumer Products 2300 Meijer Drive, Troy, MI P.O. Box 7031 (Zip 48007 7031)	48084		(303) 752 6600 (303) 752 6632
HOUSTON, TX	Commercial & Industrial Consumer Products 1240 Blalock Road, Suite 130	77055		(313) 280 4855 (313) 280-4861
KANSAS CITY, MO	Commercial & Industrial Consumer Products 535 E. 14th Ave., N. Kansas City, MO	64116		(713) 932 6472 (713) 932 6682 (816) 426-8272
LONG ISLAND, NY	26 45 Brooklyn Queens Expressway Woodside, NY	11377		(718) 626 1900
LOS ANGELES, CA	Commercial & Industrial Consumer Products 333 City Boulevard West Suite 700, Orange, CA	92668		(714) 938 6113 (714) 938 6141 (203) 238 6880
MERIDEN, CT	250 Pomoroy Avenue P.O. Box 910	06450		
MEMPHIS, TN	1775 Moriah Wood Blvd., P.O. Box 17369	38117 38187		(901) 762 4327
MILWAUKEE, WI	11950 W. Lake Park Dr., Suite 290	53224		(414) 359 1200
MINNEAPOLIS, MN	Suite 80, Plymouth, MN	55441		(612) 553 2100 (612) 553 2120
NEWARK, NJ	Commercial & Industrial Consumer Products 7 Ridgedale Ave., Cedar Knolls, NJ	07927		(201) 292 7220 (201) 292 7210
NEW YORK, NY	Commercial & Industrial Consumer Products 570 Lexington Avenue, Suite 2110	10022		(212) 836 3501
(See Long Island Above)				
OAKLAND, CA	Commercial & Industrial Consumer 100 Swan Way, #205 P.O. Box 2530	94621 94614		(415) 436 9450
PHILADELPHIA, PA	Commercial & Industrial Consumer Products 6000 Stoneridge Mall Rd., Suite 400, Piasanton, CA	94588 19341		(415) 734 3200
PITTSBURGH, PA	Commercial & Industrial Consumer Products 1370 Washington Pike, Bridgeville, PA P.O. Box 2832, Pittsburgh, PA	15017 15230		(215) 458 6178 (215) 458 6162
PORTLAND, OR	Commercial & Industrial Consumer Products 10200 S.W. Nimbus Ave., Bldg #G2 Tigard, OR	97223 84121		(412) 221 6320 (412) 221 2111 (503) 639 8813
SALT LAKE CITY, UT	Commercial & Industrial Consumer Products 1787 E. Fort Union Blvd., Suite 102			(801) 942 7656 (801) 942 7552
SEATTLE, WA	Commercial & Industrial Consumer Products 549 South Dawson Street P.O. Box 3877	98108 98124		(206) 767 5430 (206) 767 4569 (314) 997 8000 (813) 972 4113
ST. LOUIS, MO	Commercial & Industrial Consumer Products 1844 Lackland Hill Parkway	63146		
TAMPA, FL	10500 University Center Dr., Suite 140 P.O. Box 16626	33612 33687		
WASHINGTON, DC	7115 A Thomas Edison Dr., Columbia, MD	21046		(202) 621-8234*

\*Washington, D.C. Telephone Number

## CANADA

City	Address	Area Code	Exchange	Facsimile
ST. JOHN'S, NF	A1E 4V8 P.O. Box 7459	(709)	364 3955	364-3955
DARTMOUTH, NS	B3B 1R8 50 Akerley Blvd., Suite 'N'	(902)	469 5697	465-1057
QUÉBEC (Qc)	G1N 2E2 1130 ouest, boul. Charest	(418)	681-7817	682-8560
ST-LAURENT (Qc)	H4S 1W8 2425 boul. Pitfield	(514)	333 2714	333 2795
MISSISSAUGA, ONT	L6N 5P9 2300 Meadowvale Blvd.	(416)	858 5390	858 5653
WINNIPEG, MB	R3G 3J7 Suite 107, 902 St. James St.	(204)	772-8786	774 5634
EDMONTON, AB	T5M 3T3 11612 163 Street	(403)	451 3673	452 7564
CALGARY, AB	T2H 1Z6 5740 Burbank Cres. South East	(403)	253 6552	255 4834
VANCOUVER, BC	V5M 3M5 2096 Noortka Street	(604)	253 1557	253-5110 (604) 253-1658

In addition to the Sales Offices in the cities listed above, GE Lamp Sales Representatives are resident in other cities. Consult your telephone directory under GE Lighting.

## PANAFAX AND MAIL ORDERS:

### Commercial & Industrial Customers

Previous Order Site	New Order Site National Customer Service Ctr.
Boston/Baltimore	TEL 1-800-327-8050 FAX 1-800-327-0442 P.O. 4701 23060
New York	TEL 1-800-327 0097 FAX 1-800 544 4835 P.O. 4701 23060
Philadelphia/Detroit	TEL 1-800-327 6035 FAX 1-800-327 0511 P.O. 4701 23060
Cleveland	TEL 1-800-327 8060 FAX 1-800-327 0405 P.O. 4701 23060
Chicago/Milwaukee	TEL 1-800-327-8540 FAX 1-800-327 0644 P.O. 4701 23060
Cincinnati	TEL 1-800 327-6045 FAX 1-800-327 0533 P.O. 4701 23060
Atlanta/Memphis	TEL 1-800 327-5045 FAX 1-800-327-0499 P.O. 4702 23060
Charlotte/Tampa	TEL 1-800 327-7065 FAX 1-800-327-0535 P.O. 4702 23060
Dallas/Houston New Orleans	TEL 1-800 327 7105 FAX 1-800 544-4830 P.O. 4702 23060
Los Angeles	TEL 1-800 327 8565 FAX 1-800 544 4875 P.O. 4703 23060
Oakland	TEL 1-800 327 1130 FAX 1-800 327 0663 P.O. 4703 23060
Denver/Seattle	TEL 1-800 327 0755 FAX 1-800 327 0702 P.O. 4703 23060
Kansas City/St. Louis Minneapolis	TEL 1-800 327 3165 FAX 1-800 327 0465 P.O. 4703 23060

### Retail Customers

Previous Order Site	New Order Site National Customer Service Ctr.
Boston/New York/Philadelphia Tampa/Charlotte	TEL 1-800 327 2080 FAX 1-800 544 4850 P.O. 4711 23060
Cleveland/Chicago/Minneapolis Milwaukee/Cincinnati	TEL 1-800 327 3175 FAX 1-800 327 0655 P.O. 4712 23060
Kansas City/Detroit/St. Louis Atlanta/Baltimore/Memphis Puerto Rico	TEL 1-800-327 8570 FAX 1-800-327-0488 P.O. 4712 23060
Los Angeles/Oakland/Seattle	TEL 1-800 327-2010 FAX 1-800-327-0094 P.O. 4713 23060
Denver/Dallas/Houston New Orleans	TEL 1-800 327-9045 FAX 1-800-327-0611 P.O. 4713 23060

### National Account Customers

Mass Merchandisers	TEL 1-800 544 4765 FAX 1-800 544 4695
Drug	TEL 1-800 544 4780 FAX 1-800 544 4695
Home Centers	TEL 1-800 544 4740 FAX 1-800 544 4695
Hardware Headquarters	TEL 1-800 544 4785 FAX 1-800 544 4695
Hardware Branches	TEL 1-800 544 4740 FAX 1-800 544 4695

## CANADA

TEL 1-416-858-8063 FAX 1-800-263-5835

## LIGHTING INFORMATION CENTER

Product & Application Technical Information (216) 266 3900  
FAX (216) 266 8346

### IF SALES REP IS UNAVAILABLE

#### For Sales Information:

GE Lamps (C&I) 1-800 435 2677  
GE Light (Consumer) 1-800 435 4448

### GE ANSWER CENTER

Consumer Products Information 1-800 626 2000

## NATIONAL CUSTOMER SERVICE CENTER

4400 Cox Road Glen Allen, VA 23060 (804) 965 1020

## MASTER DISTRIBUTION CENTERS

ATLANTA	1700 Westgate Parkway, Atlanta, GA 30336
CHICAGO	7770 West 71st Street, Bridgeview, IL 60455
DALLAS	2080 McDaniel, P.O. Box 115035, Carrollton, TX 75011 5035
HAGERSTOWN	Martin Road, Route 6, Box 255A, Hagerstown, MD 21740
KANSAS CITY	535 East 14th Ave., North Kansas City, MO 64116
ONTARIO	701 Malaga Place, Ontario, CA 91761
GOSHEN	Maple Avenue Ext., Westgate Industrial Park, Goshen, NY 10924
RAVENNA	150 Loomis Parkway, Ravenna, OH 44266
SEATTLE	549 South Dawson Street, Box 3877, Seattle, WA 98124

FOR INTERNATIONAL GE LAMP SALES LOCATIONS, CONTACT  
INTERNATIONAL MARKETING DEPARTMENT, NELA PARK,  
CLEVELAND, OHIO 44112  
PHONE (010 1 216) 266-2653, FAX 266-2371, TELEX 980390



**GE Lighting**

General Offices: Nela Park, Cleveland, Ohio 44112